



Texas Fluorescents
Reinvented

CATALOG# : _____
PROJECT : _____
TYPE : _____

Series 66W

LED Wall Mount Linear 6" X 6"

This spec-grade 6" X 6" fixture is ideal for general or perimeter lighting applications where a bolder size is required and can be installed individually or in group patterns. Specially designed for dedicated direct light, indirect light or both (indirect allows a snap-in lens to hide the lamps or LED arrays). Ideal for corridors, lobbies, and office areas, etc.

CONSTRUCTION

Die-formed and welded 22-gauge cold-rolled steel. Knockouts on ends allow continuous wireway mounting. Housing is specially designed for direct and/or indirect lighting with separating compartments for each.

DIFFUSERS

Fixture accepts various lenses or louvers.

TYPICAL OPTIONS & ACCESSORIES

Cord sets, whips, occupancy sensors, hanging kits, wire guards. Emergency battery backup options available. Contact factory for more details.



DIMENSIONS

4ft. - 48"L x 6"W x 6"H
8ft. - 96"L x 6"W x 6"H
Custom lengths available; contact factory

FEATURES & BENEFITS

- Wall mounted; can also be surface, recess or pendant mounted
- For individual use or lined up in a continuous row, resulting in a clean line of light
- Recommended for commercial & residential applications
- Custom finishes available; contact factory
- CRI: >80 standard, 90 optional
- L70: >50,000 Hours
- Dimming: 0-10V 120-277V standard, 120V ELV/TRIAC optional
- Several Kelvin temperature options (3000K, 3500K, 4000K, 5000K)
- Emergency backup options available
- Power Factor: >0.90
- Suitable for damp and dry locations
- 5-Year Warranty



ORDERING GUIDE

2 Ft.

SERIES	MOUNTING	DIFFUSER	LENGTH	GEAR	UP WATTAGE *1	DOWN WATTAGE *
66	W Wall	SF Snap-in frosted acrylic lens (85% transmission) Special for LEDs; only available for uplight and downlight	24 24"	LR	U6 6 Watts 600 Lumens	D12 12 Watts 1200 Lumens
					U9 9 Watts 900 Lumens	D18 18 Watts 1800 Lumens
					<u>Up or Downlight Only</u>	
					D12 12 Watts 1200 Lumens	D24 24 Watts 2400 Lumens

DRIVER	UP/DOWN CONTROL	FINISH ²	CRI/CCT ³	CONFIGURATION
DMV 120-277VAC 0-10V Dimming	Blank Paired Up/Down Dimming+control	WH White BK Black	30K 3000K 80 CRI	Blank Individual -B Beginner Run
G120 ELV/TRIAC Dimming at 120V only	11 Separate Up/Down Dimming+control	SI Silver ** Custom Color	35K 3500K 80 CRI	-E Ender Run -J Joiner
D1MV 120-277VAC 0-10V Dimming (dim to 1%)			40K 4000K 80 CRI	
SRMV 120-277VAC Phillips Sensor-Ready			50K 5000K 80 CRI	
DALMV 120-277VAC DALI Dimming			930K 3000K 90 CRI	
			935K 3500K 90 CRI	
			940K 4000K 90 CRI	

OPTIONS

HANGING KIT	SENSOR
HC301WH Cable kit with 4' cable & 3 wires power feed/cable incl. and white canopy	SS On/Off Sensor
HC302WH Cable kit with 12' cable & 3 wires power feed/cable incl. and white canopy	SV Bi-Level Sensor
HC3015WWH Cable kit with 4' cable & 5 wires power feed/cable incl. and white canopy	SD Daylight Harvesting Sensor
HC3025WWH Cable kit with 12' cable & 5 wires power feed/cable incl. and white canopy	SM Microwave Sensor
HC3016WH Cable kit with 4' cable & 6 wires power feed/cable incl and white canopy	
HC3026WH Cable kit with 12' cable & 6 wires power feed/cable incl and white canopy	
2SCS24WH Two stem kits with 24" stem, canopy and mounting hardware for a 4' fixture	

Note:

1. Uplight and downlight not available in combination for 2 ft fixtures. Consult factory for more information.
2. **RAL custom finishes available. Consult factory for more information or pricing requests.
3. Consult factory for 90 CRI 5000K availability.

*Programmable LED drivers allow custom configured wattages and corresponding lumens.

We reserve the right to change design, materials, LED's and finish in any way that will not alter installed appearance or reduce function and performance.

ORDERING GUIDE

4 Ft. and 8 Ft.

SERIES	MOUNTING	DIFFUSER	LENGTH	GEAR	UP WATTAGE *1	DOWN WATTAGE *1
66	W Wall	SF Snap-in frosted acrylic lens (85% transmission) Special for LEDs; only available for uplight and downlight	48 48"	LR	U12 12 Watts, 1200 Lumens	D24 24 Watts, 2400 Lumens
					U18 18 Watts, 1800 Lumens	D36 36 Watts, 3600 Lumens
						<u>Up or Downlight Only</u>
					D24 24 Watts, 2400 Lumens	D48 48 Watts, 4800 Lumens
			96 96"	LR	U24 24 Watts, 2400 Lumens	D48 48 Watts, 4800 Lumens
					U36 36 Watts, 3600 Lumens	D72 72 Watts, 7200 Lumens
						<u>Up or Downlight Only</u>
					D48 48 Watts, 4800 Lumens	D96 96 Watts, 9600 Lumens

DRIVER	UP/DOWN CONTROL	FINISH ²	CRI/CCT ³	CONFIGURATION	EMERGENCY
DMV 120-277VAC 0-10V Dimming	Blank Paired Up/Down Dimming+control	WH White	30K 3000K 80 CRI	Blank Individual	EM14 14W Emergency battery backup (integrated in fixtures 4' and longer)
G120 ELV/TRIAC Dimming at 120V only	11 Separate Up/Down Dimming+control	BK Black	35K 3500K 80 CRI	-B Beginner Run	
D1MV 120-277VAC 0-10V Dimming (dim to 1%)		SI Silver	40K 4000K 80 CRI	-E Ender Run	
SRMV 120-277VAC Phillips Sensor-Ready		** Custom Color	50K 5000K 80 CRI	-J Joiner	
DALMV 120-277VAC DALI Dimming		3000K 90 CRI	940K 4000K 90 CRI		
		3500K 90 CRI			
		3500K 90 CRI			
		3500K 90 CRI			

OPTIONS

HANGING KIT		SENSOR	
HC301WH	Cable kit with 4' cable & 3 wires power feed/cable incl. and white canopy	SS	On/Off Sensor
HC302WH		SV	Bi-Level Sensor
HC3015WWH		SD	Daylight Harvesting Sensor
HC3025WWH			
HC3016WH			
HC3016WH		SM	Microwave Sensor
2SCS24WH			

Note:

- Uplight and downlight not available in combination for 2 ft fixtures. Consult factory for more information.
- **RAL custom finishes available. Consult factory for more information or pricing requests.
- Consult factory for 90 CRI 5000K availability.

*Programmable LED drivers allow custom configured wattages and corresponding lumens.

We reserve the right to change design, materials, LED's and finish in any way that will not alter installed appearance or reduce function and performance.

DRAWINGS & IMAGES WALL MOUNT

24L

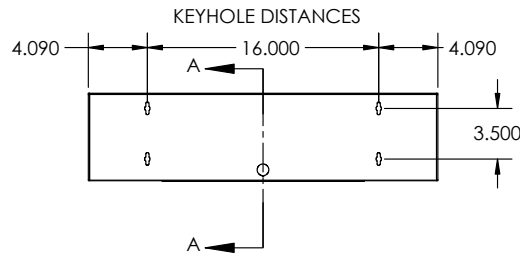
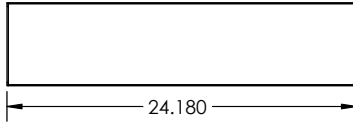

48L

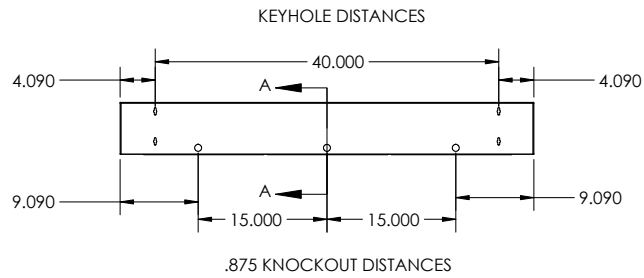
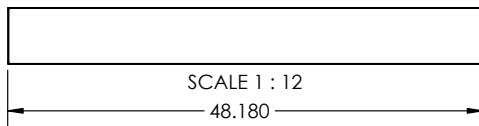

72L

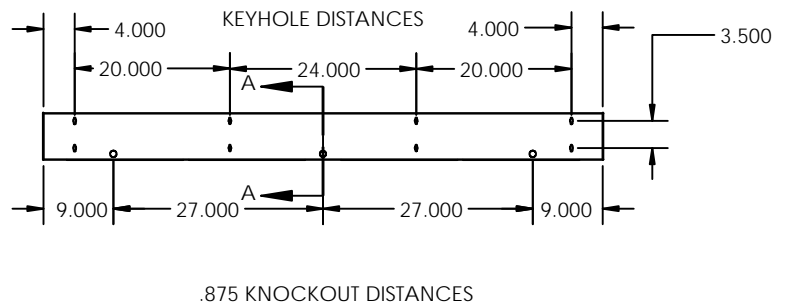
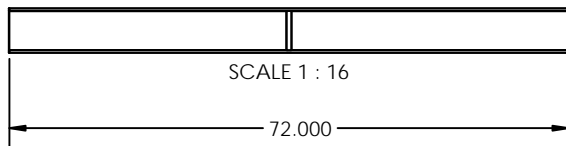

96L

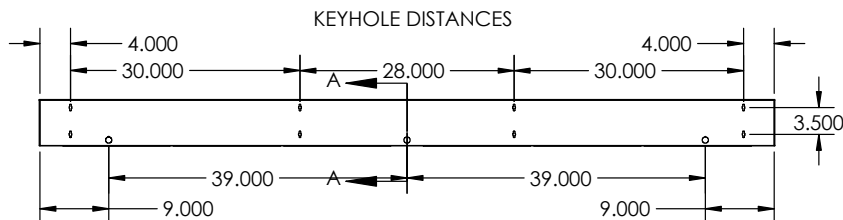

.875 KNOCKOUT DISTANCES

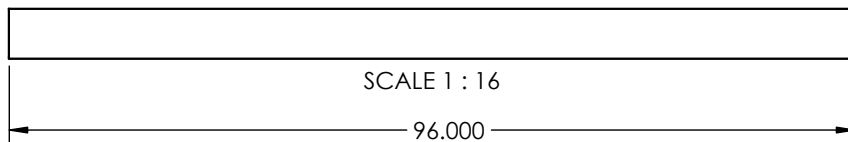

End Side View

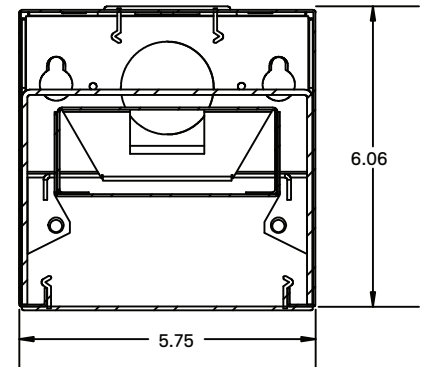

REPLACEMENT LENS ORDERING INFORMATION

SERIES	DESCRIPTION
066PSF24L	Replacement Snap-in Frosted lens for 24"
066PSF48L	Replacement Snap-in Frosted lens for 48"
066PSF96L	Replacement Snap-in Frosted lens for 96"

PHOTOMETRICS

48L-66PSF48LR48W4800LDMV40K

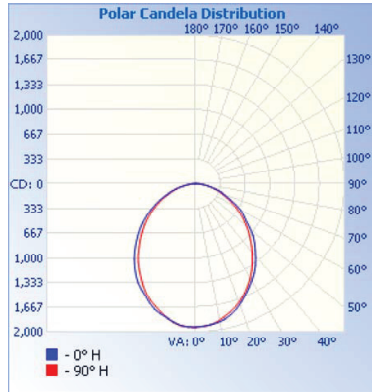

Zonal Lumen Summary

Zone	Lumens	% Luminaire
0-30	1,436.8	30.5%
0-40	2,288.0	48.6%
0-60	3,828.5	81.4%
60-90	872.7	18.6%
70-100	362.4	7.7%
90-120	2.8	0.1%
0-90	4,701.3	99.9%
90-180	2.8	0.1%
0-180	4,704.0	100%

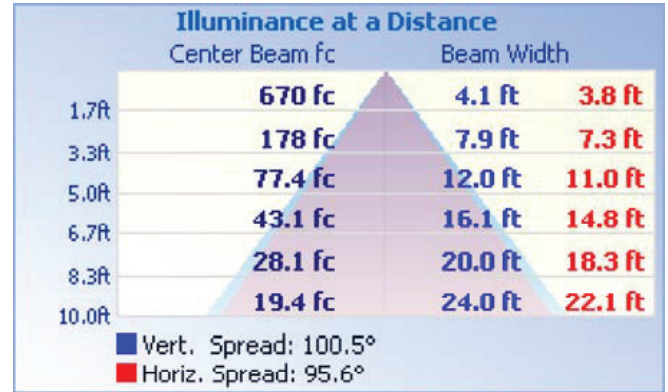

96L-66PSF96LR96W9600LDMV40K

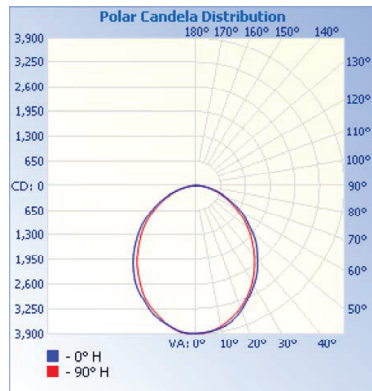

Zonal Lumen Summary

Zone	Lumens	% Luminaire
0-30	2,886.3	30.5%
0-40	4,596.4	48.6%
0-60	7,691.2	81.4%
60-90	1,753.2	18.6%
70-100	727.9	7.7%
90-120	5.6	0.1%
0-90	9,444.4	99.9%
90-180	5.6	0.1%
0-180	9,450.0	100%

