

Series SPS

Commercial Grade Pole

Straight, square steel light pole fabricated from the highest grade structural steel meeting standard requirement for commercial applications. It conforms to ASTM-A-500 Grade B and yield strength of 46,000 PSI. Polyester powder-coat finish on sandblasted with surface chemical treated to ensure maximum paint adhesion. Wall thickness available in 11 gauge or 7 gauge. Pole Top and base cover are included. A large variety accessory options, such as arms, tenon top, bullhorn, slip fitter, bracket, etc.

CONSTRUCTION

POLE - The pole shaft is fabricated from highest grade structural steel having a minimum yield of 46,000 PSI and conforms to ASTM A500 grade B requirements. The shaft construction is a single piece of formed steel welded longitudinally.

ANCHOR BOLTS(sold separate) - The anchor bolt is fabricated from a structural quality hot rolled carbon steel plate that has a minimum yield strength of 36,000 PSI. Fully galvanized anchor bolt included 2 nuts and 3 washers.

BASE COVER - A full base cover is provided which encapsulates the base plate and anchor bolts to provide a clean transition from pier to pole.

FINISH - A Super Durable Polyester powder coat finish. Standard color available: Bronze. Custom colors available upon request.



DIMENSIONS

Size: 4"x4", 5"x5"

Height: 15', 20', 25', 30'

FEATURES & BENEFITS

- Highest grade structural steel
- A minimum yield of 46,000 PSI
- ASTM A500 grade B
- A single piece of formed steel welded longitudinally
- 11 Gauge or 7 Gauge
- Reinforced cast iron hand-hole plate
- Polyester powder-coat finish on sandblasted
- Chemical treated to ensure maximum paint adhesion.
- Bronze finish
- Custom length and finish available

DRAWINGS & IMAGES

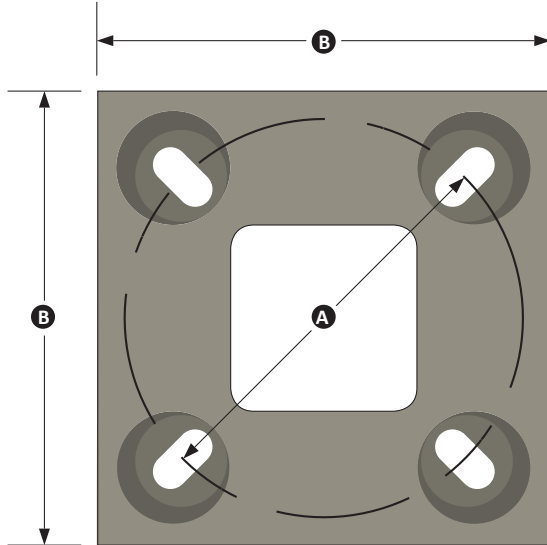

Anchor bolt template

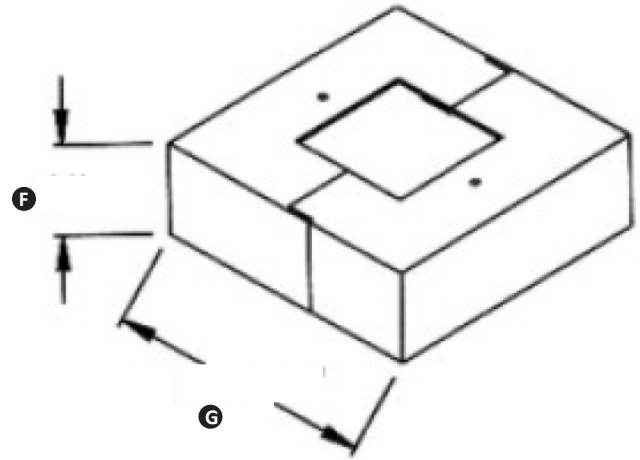

Base Cover

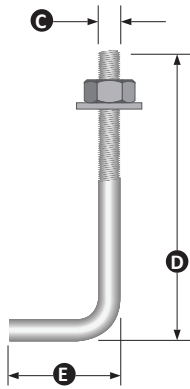

Anchor bolt

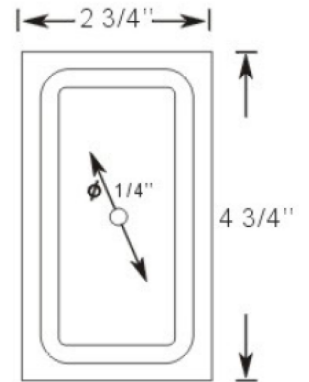
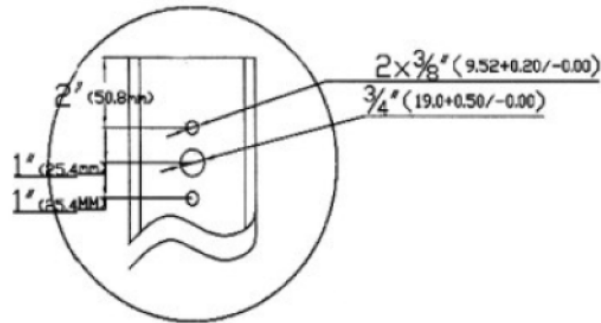

Access Plate

Size	A	B	C	D	E	F	G	Pole Weight	Anchor Weight
SPS16411	9.50"	10.75"	0.75"	30.00"	4.00"	4.00"	10.75"	126 LBS	5 LBS
SPS20411	9.50"	10.75"	0.75"	30.00"	4.00"	4.00"	10.75"	146 LBS	5 LBS
SPS25411	9.50"	10.75"	0.75"	30.00"	4.00"	4.00"	10.75"	176 LBS	5 LBS
SPS20511	11.00"	11.25"	1.00"	36.00"	4.00"	4.00"	11.25"	193 LBS	9 LBS
SPS25511	11.00"	11.25"	1.00"	36.00"	4.00"	4.00"	11.25"	241 LBS	9 LBS
SPS3057	11.00"	11.25"	1.00"	36.00"	4.00"	4.00"	11.25"	406 LBS	9 LBS
SPS30511	11.00"	11.25"	1.00"	36.00"	4.00"	4.00"	11.25"	290 LBS	9 LBS



Texas Fluorescents
Reinvented

CATALOG#: _____

PROJECT: _____

TYPE: _____

Series SPS

Commercial Grade Pole

WIND SPECIFICATIONS

Pole	80 MPH Max EPA	80 MPH Max Fixture weight (LBS)	90 MPH Max EPA	90 MPH Max Fixture weight (LBS)	100 MPH Max EPA	100 MPH Max Fixture weight (LBS)
SPS16411	15.80	399	12.30	348	9.60	312
SPS20411	10.10	320	7.60	279	5.70	255
SPS25411	6.20	250	6.50	225	4.30	200
SPS20511	16.50	411	20.00	372	14.90	318
SPS25511	10.00	250	14.80	279	10.20	235
SPS3057	12.80	321	24.10	271	17.50	238
SPS30511	6.10	250	8.40	200	8.50	212

Pole	110 MPH Max EPA	110 MPH Max Fixture weight (LBS)	120 MPH Max EPA	120 MPH Max Fixture weight (LBS)	125 MPH Max EPA	125 MPH Max Fixture weight (LBS)
SPS16411	8.90	274	6.90	236	6.10	219
SPS20411	4.90	230	3.40	219	2.60	204
SPS25411	3.10	171	2.20	156	1.30	141
SPS20511	11.50	281	8.80	242	7.60	224
SPS25511	7.10	195	4.70	154	3.50	128
SPS3057	13.00	205	9.40	170	7.60	153
SPS30511	6.30	176	5.40	135	2.70	119

Pole	130 MPH Max EPA	130 MPH Max Fixture weight (LBS)	140 MPH Max EPA	140 MPH Max Fixture weight (LBS)	150 MPH Max EPA	150 MPH Max Fixture weight (LBS)
SPS16411	5.40	203	4.10	175	3.10	150
SPS20411	2.20	180	1.3	156	0.50	135
SPS25411	0.50	112	0	65	0	55
SPS20511	6.60	205	4.90	173	3.60	150
SPS25511	2.80	103	1.40	85	0.20	45
SPS3057	6.70	125	4.50	98	2.80	70
SPS30511	1.70	95	1.20	78	0.60	35

ACCESSORIES SPECIFICATIONS



Part Number	Descriptions	Finish	Weight (LBS)
TEN4	4" Square Verical Tenon	Bronze	2.70
TEN5	5" Square Verical Tenon	Bronze	2.90

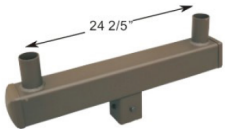

Part Number	Descriptions	Finish	Weight (LBS)
TB2180	4"x4" 2 Light Square Bullhorn	Bronze	35

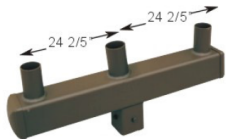

Part Number	Descriptions	Finish	Weight (LBS)
TV3	3 Light Square Bullhorn	Bronze	40

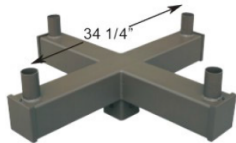

Part Number	Descriptions	Finish	Weight (LBS)
TB490	4 Light Square Bullhorn	Bronze	65

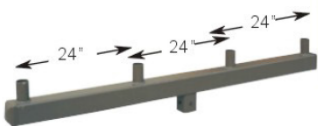

Part Number	Descriptions	Finish	Weight (LBS)
TV4	4 Light Square Bullhorn	Bronze	65



DC570BR
2 Piece U-bracket



DC570SW
Adjustable Slip Fitter



ARM6
Mounting Arm 6"



ARM10
Mounting Arm 10"

CATALOG#: _____
PROJECT: _____
TYPE: _____

PRODUCT NUMBERS

ITEM NUMBER	DESCRIPTION
SPS16411	4" x 4" Square Pole, 16ft Height, 11 Gauge, Bronze Finish
SPS20411	4" x 4" Square Pole, 20ft Height, 11 Gauge, Bronze Finish
SPS25411	4" x 4" Square Pole, 25ft Height, 11 Gauge, Bronze Finish
SPS20511	5" x 5" Square Pole, 20ft Height, 11 Gauge, Bronze Finish
SPS25511	5" x 5" Square Pole, 25ft Height, 11 Gauge, Bronze Finish
SPS3057	5" x 5" Square Pole, 30ft Height, 7 Gauge, Bronze Finish
SPS30511	5" x 5" Square Pole, 30ft Height, 11 Gauge, Bronze Finish