

Series 201

LED Narrow 5.75" Wraparound Surface Mount

This Series 201 wraparound is suitable for a wide variety of applications, such as hallways and smaller spaces with corners. It has a narrow cross-section, a full wireway for more uniform light distribution and a clear acrylic #8 pattern lens. The Series 201 features chaise nipple end caps for continuous run layouts.

CONSTRUCTION

Housing is 22 gauge baked white enamel cold-rolled steel body and ends. 20 gauge can be supplied. Wiring knockouts are provided on back and end of housing. Lens is held with "lift-and-shift" method. Uses a crystal clear prismatic diffuser extruded from 100% virgin acrylic that will maintain its color under normal conditions, indefinitely.

MOUNTING

Surface mount or suspended.

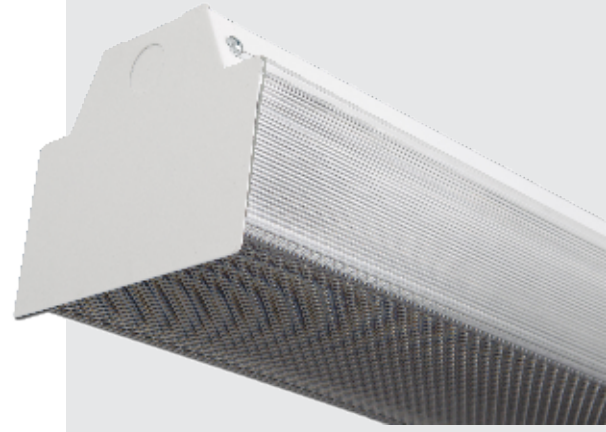

DIMENSIONS

4 ft.- 48L x 5.75W x 4.60H

8 ft.- 96L x 5.75W x 4.60H

FEATURES & BENEFITS

- Available in 4ft and 8ft
- Easy Installations
- Ideal for kitchen, laundry rooms, garage or office
- Variety of lumen packages / wattages through use of programmable drivers
- Multiple color temperatures available (3000K, 3500K, 4000K and 5000K); consult factory for RGBW option
- Emergency battery backup available
- CRI: >80 standard, 90 optional
- L70: >50,000 hrs
- Dimming: 0-10V 120-277V standard, 120 ELV/TRIAC optional
- Power factor: >0.90
- Suitable for dry and damp locations
- 5 year warranty



CATALOG#: _____
 PROJECT: _____
 TYPE: _____

Series 201

LED Narrow 5.75" Wraparound
 Surface Mount

ORDER INFORMATION

Factory at your fingertips. Fill in the blanks to create your part number or create a custom configuration.

SERIES	LENS MATERIAL	LENGTH	WATTAGE* & LUMENS*	DRIVER	COLOR**	
201	A Clear Prismatic Acrylic #8 Pattern	48L 48"	S24W2800L	24 Watts 2800 Lumens	DMV 0-10V Dimming G120 ELV/TRIAC Dimming at 120V only D1MV 0-10V Dimming (dim to 1%)	30K 3000K 80CRI
			S32W4000L	32 Watts 4000 Lumens		35K 3500K 80CRI
			S48W5700L	48 Watts 5700 Lumens		40K 4000K 80CRI
			H72W8700L	72 Watts 8700 Lumens		50K 5000K 80CRI
		96L 96"	S48W5600L	48 Watts 5600 Lumens		930K 3000K 90CRI
			S65W8000L	65 Watts 8000 Lumens		935K 3500K 90CRI
			S97W11400L	97 Watts 11400 Lumens		940K 4000K 90CRI
						950K 5000K 90CRI

OPTIONS	
WP	6ft. 3 wire 18 gauge whip
WP10	6ft. 4 wire 18 gauge whip
WG	Wire Guard

*Programmable LED drivers allow custom configured wattages and corresponding lumens.
 ** Consult factory 5000K 90CRI availability.
 NOTE: Values shown are typical or recorded under standardized conditions at 25°C. Actual performance may vary based environment or application. Specifications are subject to change without notice. We reserve the right to change design, materials, LED's and finish in any way that will not alter installed appearance or reduce function and performance.

DRAWINGS & IMAGES

END

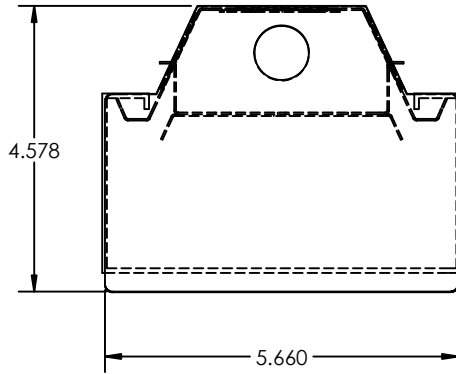

LENS OPTIONS

SERIES	DESCRIPTIONS
0201A48L	Replacement Acrylic lens for 48"L
0201A96L	Replacement Acrylic lens for 96"L

48L BACK

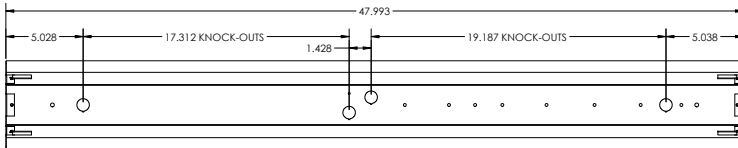

96L BACK

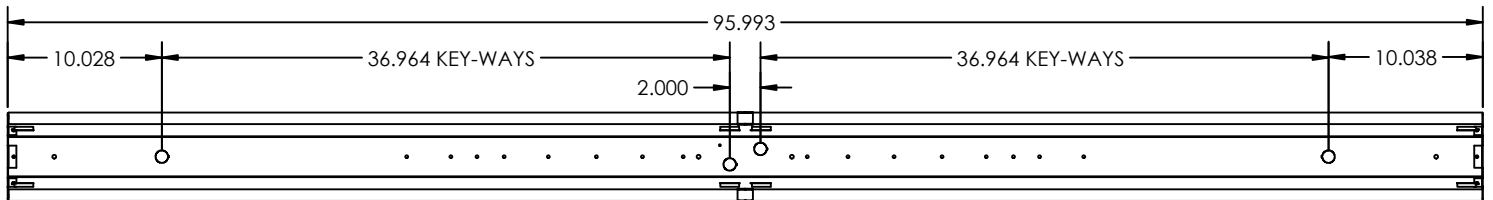

PHOTOMETRICS

201A48LH72W8700LDMV40K

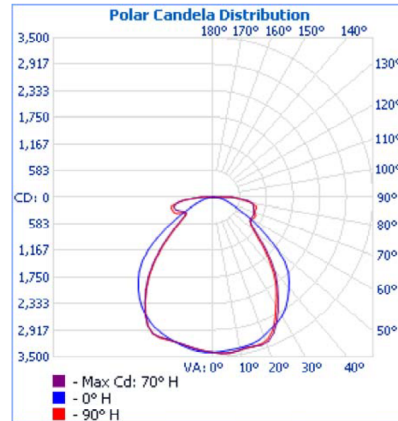
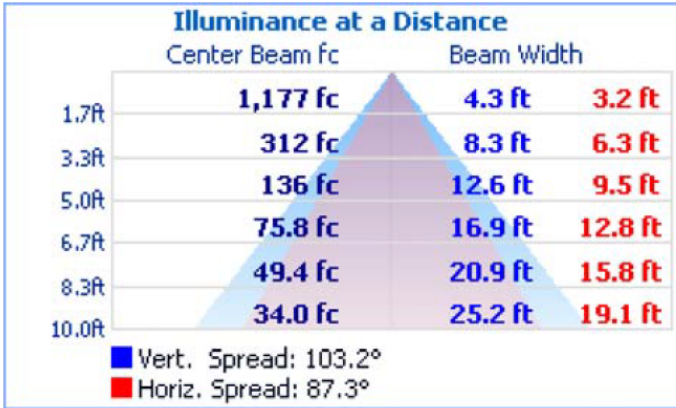

Zonal Lumen Summary

Zone	Lumens	% Luminaire
0-30	2,715.3	31%
0-40	4,385.0	50.1%
0-60	6,855.0	78.3%
60-90	1,802.1	20.6%
70-100	1,184.1	13.5%
90-120	97.0	1.1%
0-90	8,657.1	98.9%
90-180	97.0	1.1%
0-180	8,754.1	100%

201A48LS32W4000LDMV40K

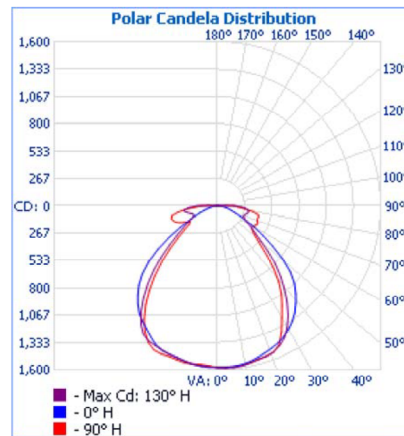
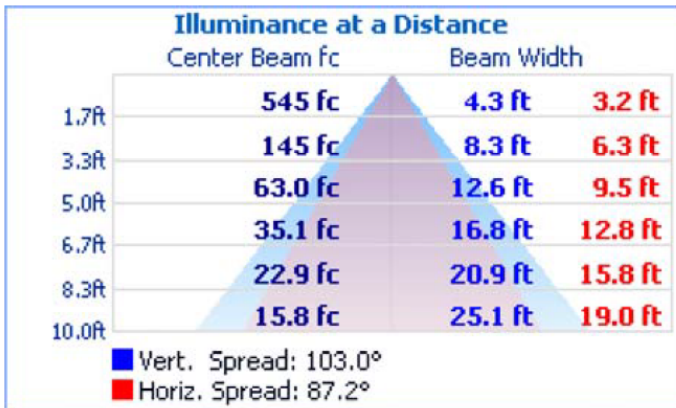

Zonal Lumen Summary

Zone	Lumens	% Luminaire
0-30	1,263.2	31.6%
0-40	2,043.7	51.2%
0-60	3,165.5	79.2%
60-90	787.6	19.7%
70-100	520.8	13%
90-120	41.4	1%
0-90	3,953.1	99%
90-180	41.4	1%
0-180	3,994.4	100%