



JOB NAME:

CAT#:

TYPE:

## APPLICATIONS

Introducing a new eye catching high efficiency LED light fixture with a narrow acoustic baffle made of sound absorbing material. Class A fire rating option available. It integrates lighting and an acoustic solution into one customizable product. The acoustic material helps create a beautiful and highly functional acoustic baffled ceiling installation. It can be combined with unlit baffles or it can be used as a stand-alone acoustic fixture. Offering multiple colors for different applications or mixing colors to create a dynamic look. Pair LED light fixture with acoustic baffles in the same or complimentary colors. Available in 1ft increments up to 8ft in length and various heights from 12" to 24". The LED light fixture slightly regressed into the acoustic housing for great lighting effect. Consult for noise reduction coefficient (NRC). For more lighting information please see the L23 series.

## FEATURES & BENEFITS

- 30+ acoustic material colors available
- Pendant mount accommodates most ceiling types
- CRI >80 (90 CRI available)
- >50,000 hrs of L<sub>70</sub> LED life
- 0-10 Volt dimmable 120-277V
- Power factor >0.90
- 5 year warranty

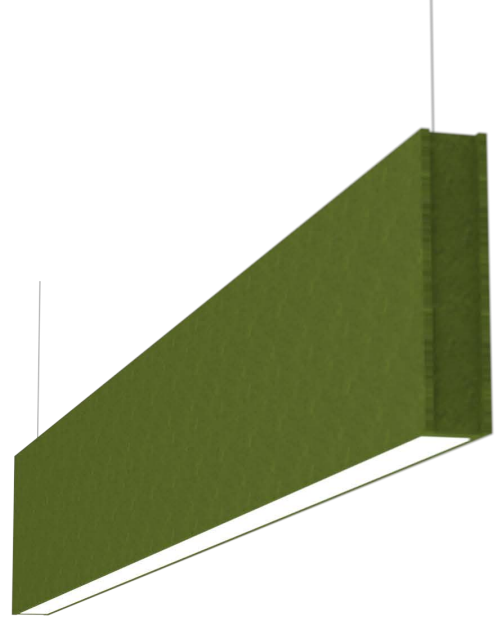

Dimensions and specifications subject to change without notice.





JOB NAME:

CAT#:

TYPE:

**ORDERING**

EXAMPLE: ABL3 24 16 LED U 23 DMV A52 W 30 EM

ABL3		LED							
1. SERIES	2. LENGTH	3. HEIGHT	4. GEAR	5. DISTRIBUTION	6. WATTAGE/LUMENS	7. DRIVER	8. FLAIR A <sup>2</sup>		
ABL3	24 25.20"	12 12"	LED	Blank Downlight (std.)	<b>Downlight or Uplight Only</b>		DMV 120-277V Multivolt 0-10V Dimmable	44 Ivory 19 Denim 11 Steel	
	48 47.28"	16 16"			<b>24 in.</b>				
	72 69.41"	24 24"			12 12 Watts 1320 Lumens	24 24 Watts 2640 Lumens			
	96 91.93"				<b>48 in.</b>				
			1U1D Uplight and Downlight	24 24 Watts 2640 Lumens	<b>48 in.</b>		D120 Triac Dimming 120VAC		
			1U2D Uplight and Downlight	48 48 Watts 5290 Lumens	<b>72 in.</b>				
			U Uplight	36 36 Watts 3960 Lumens	<b>96 in.</b>				
				72 72 Watts 7920 Lumens	<b>96 in.</b>				
					52 52 Watts 5720 Lumens	<b>1 Up and 1 Down Only</b>			
					96 96 Watts 10560 Lumens	<b>48 in.</b>			
					10 10 Watts 500U-500D	<b>1 Up and 2 Down Only</b>			
					18 18 Watts 660U-1320D	<b>24 in.</b>			
					27 27 Watts 990U-1980D	<b>48 in.</b>			
					36 36 Watts 1320U-2640D	<b>72 in.</b>			
					54 54 Watts 1980U-3960D	<b>96 in.</b>			
					54 54 Watts 1980U-3960D	<b>96 in.</b>			
					81 81 Watts 2970U-5940D	<b>96 in.</b>			
					72 72 Watts 2640U-5280D	<b>96 in.</b>			
					108 108 Watts 3960U-7920D	<b>96 in.</b>			

9. MATERIAL CLASS	10. CRI	11. COLOR TEMP	12. HANGING KIT (O) <sup>5</sup>
Blank Class B	Blank 80	30 3000K	HC605WH Cable kit with 6' cable & 5 wires power feed/cable incl., clear cord and white canopy
A Class A	9 90	35 3500K	HC605WHNPF Cable kit with 6' cable & white canopy, non power feed
		40 4000K	HC612WH Cable kit with 12' cable & 5 wires power feed/cable incl., clear cord and white canopy
		50 5000K	HC612WHNPF Cable kit with 12' cable & white canopy, non power feed

**NOTE:** Values shown are typical or recorded under standardized conditions at 25°C. Actual performance may vary based on environment or application. Specifications are subject to change without notice. We reserve the right to change design, materials, LED's and finish in any way that will not alter installed appearance or reduce function and performance.



JOB NAME:

CAT#:

TYPE:

**ACOUSTIC MATERIAL COLOR OPTIONS**

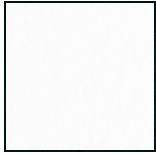

07  
White



44  
Ivory



42  
Cream



52  
Latte



53  
Smoky Beige



02  
Taupe



35  
Speckled Earth



49  
Brunette



54  
Espresso



45  
Big Red



43  
Lava



36  
Berry



50  
Caramel



41  
Marigold



55  
Tangerine



51  
Sunkist Orange

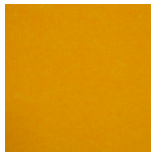

22  
Yellow



39  
Green Apple

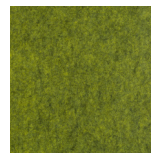

48  
Avocado

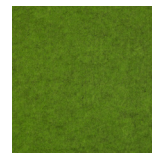

12  
Moss



05  
Dark Green



47  
Emerald



18  
Arctic Ice



30  
Blue



56  
Azure



19  
Denim



21  
Indigo Blue

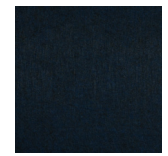

09  
Deep Blue

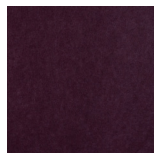

08  
Eggplant

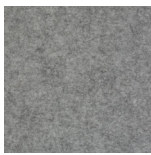

03  
Light Gray

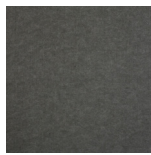

34  
Pure Gray

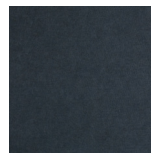

11  
Steel

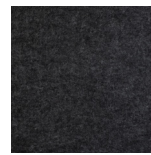

17  
Dark Gray



10  
True Black



02P  
Pecan Medium  
Brown\*



01P  
Birch Light  
Brown\*



03P  
Rich Soil\*



04P  
Grey Wash\*

\* Pecan Medium Brown & Birch Light Brown PET will incur additional cost

Dimensions and specifications subject to change without notice.



JOB NAME:

CAT#:

TYPE:

**DRAWINGS & IMAGES - Direct and Indirect**

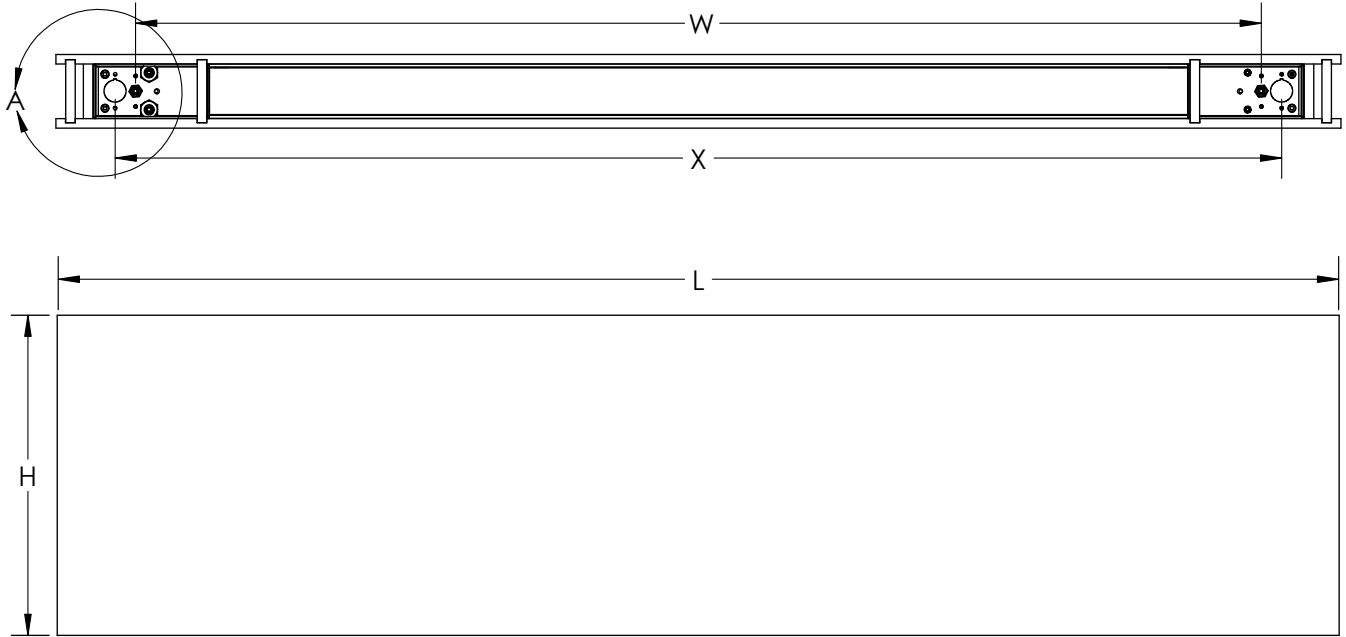

Sample Part Number	L	W	H	X
ABL324	25.20"	19.32"	12",16",24"	20.82"
ABL348	47.28"	41.42"	12",16",24"	42.92"
ABL372	79.41"	63.55"	12",16",24"	65.05"
ABL396	91.93"	86.05"	12",16",24"	87.55"

L-Length  
H-Height  
W-Hanging Kit Dimensions  
X-Power Knockouts

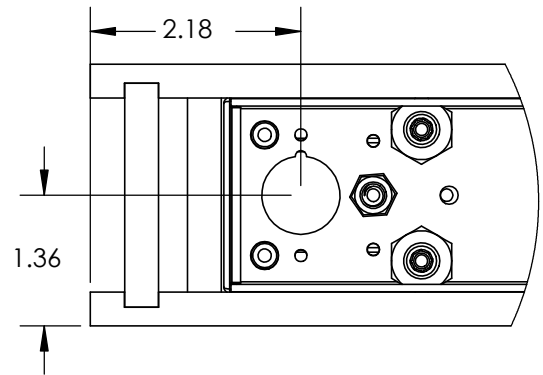

DETAIL A  
SCALE 1 : 2

Dimensions and specifications subject to change without notice.