



CATALOG#: _____
PROJECT: _____
TYPE: _____

Series AWP

LED Adjustable Wall Pack

Slim wall pack is available in two watts for a variety of applications including building perimeter, entrances, stairways and security lighting. AWP series of luminaires provides a low-profile architectural style with the power of bright, energy efficient LEDs. It has a rugged aluminum construction with multi-mount capabilities. 0 degree to +90 degree tilt adjustments. For a building that has a modern or futuristic look.

CONSTRUCTION

Sealed die-casting profile for outdoor applications. Tempered UV coated flat lens provide outstanding performance, uniformity and glare control

MOUNTING

Surface mount.



DIMENSIONS

7L - 48"L x 9.13"W x 4.2"H
10L - 10.06"L x 11.02"W x 5.09"H

FEATURES & BENEFITS

- Suitable for both indoor and outdoor application
- Die-cast aluminum housing
- 0 degree to +90 degree tilt adjustments
- Polycarbonate optical lens with UV stabilizers
- Bronze finish
- High-impact acrylic diffuser
- 120-277V
- 70 CRI
- >0.9 Power factor
- UL / cUL Wet location
- 5 year warranty for -40°C to +40°C environment



ORDER INFORMATION

ITEM NO.	DESCRIPTION
AWP7L27W3600LMV50KBZ	LED Adjustable Wall Pack / 7.29"L x 9.13"W x 4.2"H / 27W, 3600L / 120-277V / 5000K / Bronze Finish
AWP7L40W5400LMV50KBZ	LED Adjustable Wall Pack / 7.29"L x 9.13"W x 4.2"H / 40W, 5400L / 120-277V / 5000K / Bronze Finish
AWP10L67W8800LMV50KBZ	LED Adjustable Wall Pack / 10.06"L x 11.02"W x 5.09"H / 67W, 8800L / 120-277V / 5000K / Bronze Finish
AWP10L80W10500LDMV50KBZ	LED Adjustable Wall Pack / 10.06"L x 11.02"W x 5.09"H / 80W, 10500L / 120-277V / 5000K / Bronze Finish

DRAWINGS & IMAGES

7L

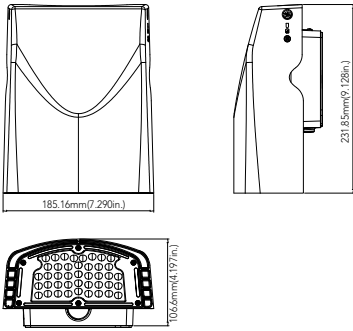

10L

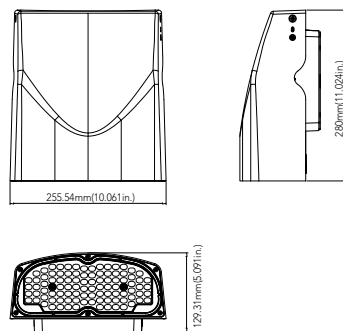

PHOTOMETRICS

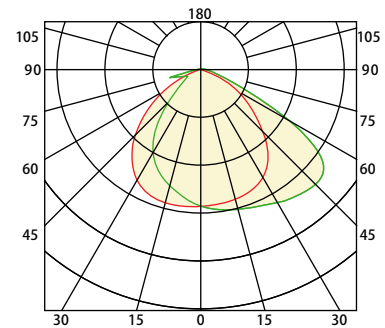

Mounting
 0° to +90° tilt adjustments. To meet the needs of customers with different lighting angles.



Housing
 Suitable for both indoor and outdoor application, also suitable for J-BOX mounting and surface mounting.



Photocell
 Optional for photocell, and allows for security and energy saving.

Photocell
 No. PC-JL-120-277V
 USE: Photocell is field installed or pre-installed in factory by requesting



Lens
 Polycarbonate optical lens with UV stabilizers do not exhibit yellowing and deformation.

Note:
 *Programmable LED drivers allow custom configured wattages and corresponding lumens.
 ** Consult factory for 90 CRI 5000K availability.
 We reserve the right to change design, materials, LEDs and finish in any way that will not alter installed appearance or reduce function and performance.

DRAWINGS & IMAGES

**Back
 2x2**

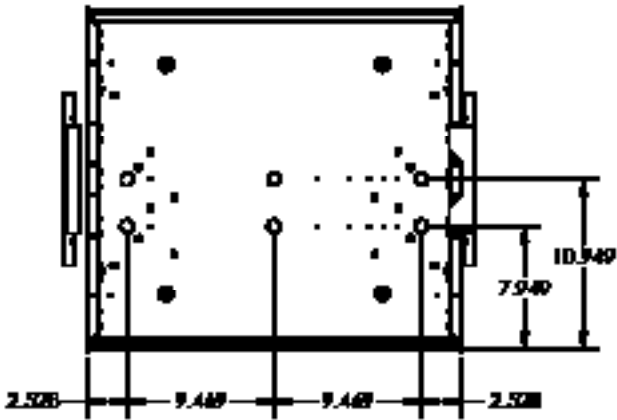

End

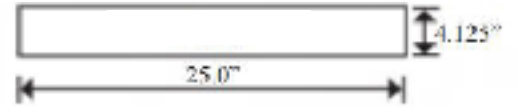

**Back
 1x4**

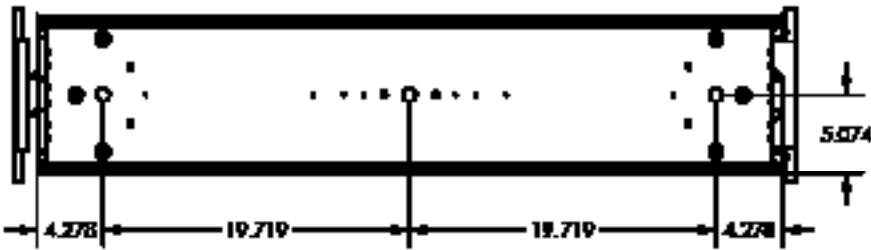

End

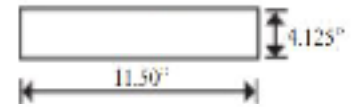

**Back
 2x4**

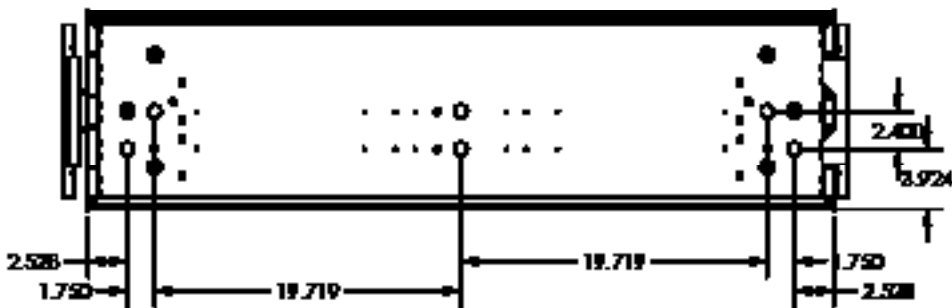

End

