



JOB NAME:

CAT#:

TYPE:

### APPLICATIONS

#### The Square/Rectangle

Transform the lighting in your space using PGN44 (polygon 4"x4") series fixtures to provide bright, white and energy efficient illumination. Choose different bracket styles and fixture lengths to construct a completely customizable lighting system with uplight and downlight options, such as squares or rectangles. Instantly revamp the look and feel of your space with interesting luminaires.

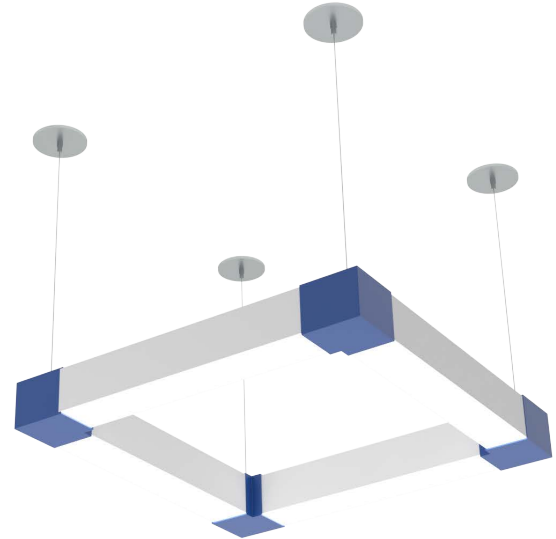

### FEATURES & BENEFITS

- 4 standard fixture sizes – 24", 48", 72", and 96"
- Customizable bracket colors available
- Pendant mount for most ceilings
- Many lumen package / wattage options via programmable drivers
- CRI >80 (90 CRI available)
- >50,000 hrs of L70 LED life
- Power factor >0.90

### DIMENSIONS

Part	L	W
PGN44-P34X34	34"	34"
PGN44-P58X58	58"	58"
PGN44-P82X82	82"	82"
PGN44-P108X108	108"	108"

L = Length  
W = Width

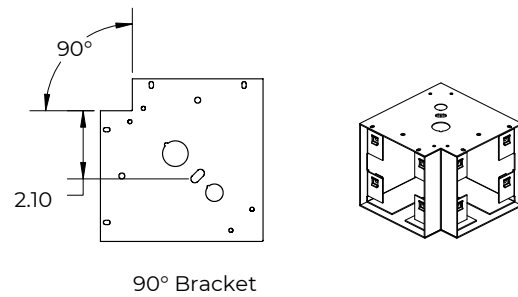
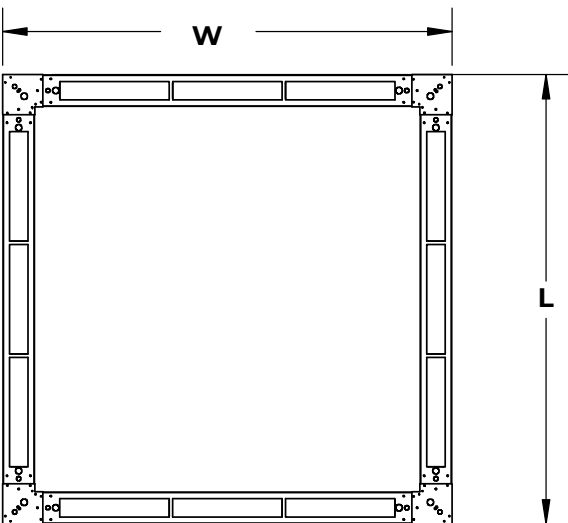

Dimensions and specifications subject to change without notice.





JOB NAME:

CAT#:

TYPE:

**ORDERING**

EXAMPLE: PGN44 P 34X34 LED 96 DMV BK SF 30 RD EM14 -SQ

**PGN44**

**P**

**LED**

1. SERIES	2. MOUNTING	3. WIDTH X LENGTH <sup>1</sup>	4. GEAR	5. DISTRIBUTION	6. WATTAGE/LUMENS <sup>2</sup>	7. DRIVER
<b>PGN44</b>	<b>P</b> Pendant	<b>34X34</b> 34"W x 34"L <b>58X58</b> 58"W x 58"L <b>82X82</b> 82"W x 82"L <b>108X108</b> 108"W x 108"L	<b>LED</b>	<b>Blank</b> Downlight (std.) <b>1U2D</b> Uplight and Downlight	<b>Downlight</b> <b>34X34 in.</b> <b>96</b> 96 Watts 9600 Lumens <b>58X58 in.</b> <b>192</b> 192 Watts 19200 Lumens <b>82X82 in.</b> <b>288</b> 288 Watts 28800 Lumens <b>108X108 in.</b> <b>384</b> 384 Watts 38400 Lumens  <b>1 Up and 2 Down Only</b> <b>34X34 in.</b> <b>152</b> 152 Watts 5600U-9600D <b>58X58 in.</b> <b>304</b> 304 Watts 11200U-19200D <b>82X82 in.</b> <b>456</b> 456 Watts 16800U-28800D <b>108X108 in.</b> <b>608</b> 608 Watts 22400U-38400D	<b>DMV</b> 120-277V Multivolt 0-10V Dimmable

8. FINISH <sup>3</sup>	9. LENS	10. CRI	11. COLOR TEMP	12. FLAIR <sup>4</sup>	13. EM (O) <sup>6</sup>	15. CONFIGURATION
<b>BK</b> Black <b>SI</b> Silver <b>WH</b> White	<b>SF</b> Snap-in Frosted Acrylic Lens (85% transmission)	<b>Blank</b> 80 <b>9</b> 90	<b>30</b> 3000K <b>35</b> 3500K <b>40</b> 4000K <b>50</b> 5000K	<b>RD</b> Red <b>BL</b> Blue <b>BK</b> Matte Black	<b>EM14</b> 14W Emergency Battery Backup <sup>5</sup>	<b>-SQ</b> Square <b>-RT</b> Rectangle

**Notes:**

- <sup>1</sup>Square/rectangle configurations are measured by an overall system width and length.
- <sup>2</sup>Wattage and lumen values are total for the system. Minimum fixture wattage of 10W. Minimum 5W per fixture foot uplight and downlight. Maximum 9W per fixture foot uplight and 18W per fixture foot downlight. Power feed cable is 18AWG, power drop is required every 800W or 48 feet for 0-10V dimming, whichever comes first. EM not available in fixtures with sections 2' and shorter if there is uplight and downlight.
- <sup>3</sup>Consult for custom finish options
- <sup>4</sup>Consult for custom flair options
- <sup>5</sup>Emergency battery backup is integrated in fixtures 4' and longer
- <sup>6</sup>(O) is optional



Dimensions and specifications subject to change without notice.



JOB NAME:

CAT#:

TYPE:

**FLAIR BRACKET COLORS AND FINISHES**



Gloss Black  
(GB)



Matte Black  
(BK)



Matte Silver  
(SL)



Statuary Bronze  
(BZ)

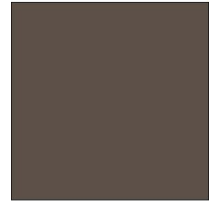

Glimmer (Iron)  
(IR)

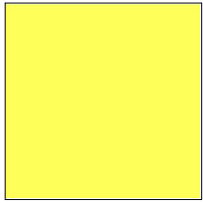

Safety Yellow  
(YL)

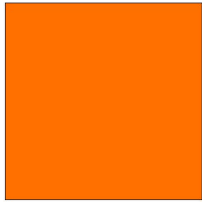

Safety Orange  
(OR)



Red  
(RD)



Fire Engine Red  
(FR)



Blue  
(BL)

**NOTE:** Factory offers any Tiger Drylac RAL finish, contact Saylite for more information. Consult factory for information on specialty "real wood" finishes.

Dimensions and specifications subject to change without notice.





JOB NAME:

CAT#:

TYPE:

### APPLICATIONS

#### The Hexagon

Transform the lighting in your space using PGN44 (polygon 4"x4") series fixtures to provide bright, white and energy efficient illumination. Choose different bracket styles and fixture lengths to construct a completely customizable lighting system with uplight and downlight options, such as The Hexagon. Instantly revamp the look and feel of your space with interesting luminaires.

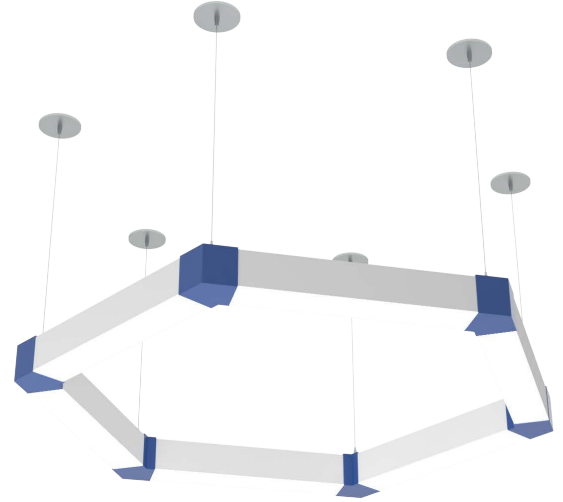

### FEATURES & BENEFITS

- 4 standard fixture sizes – 24", 48", 72", and 96"
- Customizable bracket colors available
- Pendant mount for most ceilings
- Many lumen package / wattage options via programmable drivers
- CRI >80 (90 CRI available)
- >50,000 hrs of L70 LED life
- Power factor >0.90

### DIMENSIONS

Part	D	D = Diameter
PGN44-P61	61"	
PGN44-P108	108"	
PGN44-P156	156"	
PGN44-P204	204"	

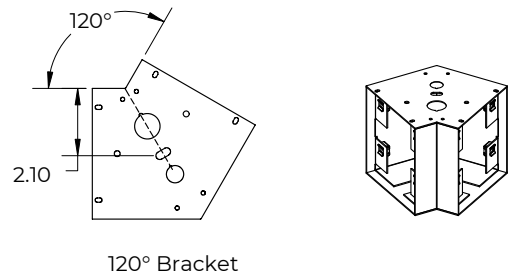
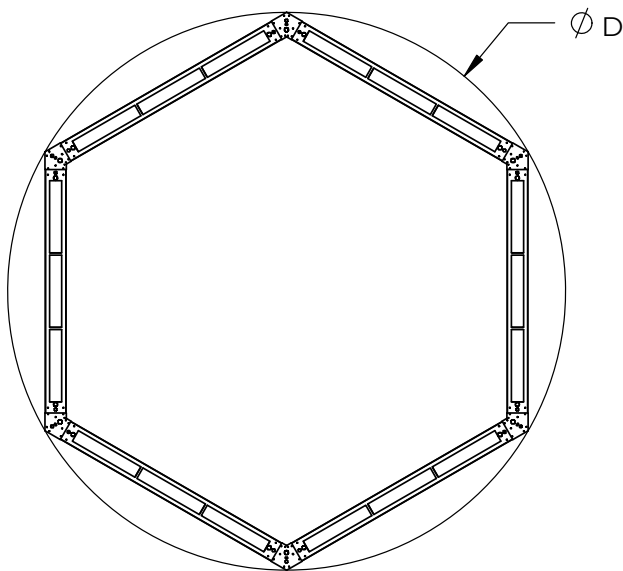

Dimensions and specifications subject to change without notice.





JOB NAME:

CAT#:

TYPE:

**ORDERING**

EXAMPLE: PGN44 P 108 LED 1U2D 456 DMV BK SF 30 RD EM14 -HX

**PGN44**

**P**

**LED**

1. SERIES	2. MOUNTING	3. DIAMETER <sup>1</sup>	4. GEAR	5. DISTRIBUTION	6. WATTAGE/LUMENS <sup>2</sup>	7. DRIVER
<b>PGN44</b>	<b>P</b> Pendant	<b>61</b> 61" Dia. <b>108</b> 108" Dia. <b>156</b> 156" Dia. <b>204</b> 204" Dia.	<b>LED</b>	<b>Blank</b> Downlight (std.) <b>1U2D</b> Uplight and Downlight	<b>Downlight</b> <b>61 in.</b> <b>144</b> 144 Watts 14400 Lumens <b>108 in.</b> <b>288</b> 288 Watts 28800 Lumens <b>156 in.</b> <b>432</b> 432 Watts 43200 Lumens <b>204 in.</b> <b>576</b> 576 Watts 57600 Lumens  <b>1 Up and 2 Down Only</b> <b>61 in.</b> <b>228</b> 228 Watts 8400U-14400D <b>108 in.</b> <b>456</b> 456 Watts 16800U-28800D <b>156 in.</b> <b>684</b> 684 Watts 25200U-43200D <b>204 in.</b> <b>912</b> 912 Watts 33600U-57600D	<b>DMV</b> 120-277V Multivolt 0-10V Dimmable

8. FINISH <sup>3</sup>	9. LENS	10. CRI	11. COLOR TEMP	12. FLAIR <sup>4</sup>	13. EM (O) <sup>6</sup>	15. CONFIGURATION
<b>BK</b> Black <b>SI</b> Silver <b>WH</b> White	<b>SF</b> Snap-in Frosted Acrylic Lens (85% transmission)	<b>Blank</b> 80 <b>9</b> 90	<b>30</b> 3000K <b>35</b> 3500K <b>40</b> 4000K <b>50</b> 5000K	<b>RD</b> Red <b>BL</b> Blue <b>BK</b> Matte Black	<b>EM14</b> 14W Emergency Battery Backup <sup>5</sup>	<b>-HX</b> Hexagon

**Notes:**

- <sup>1</sup>Hexagon configurations are measured by overall system diameter.
- <sup>2</sup>Wattage and lumen values are total for the system. Minimum fixture wattage of 10W. Minimum 5W per fixture foot uplight and downlight. Maximum 9W per fixture foot uplight and 18W per fixture foot downlight. Power feed cable is 18AWG, power drop is required every 800W or 48 feet for 0-10V dimming, whichever comes first. EM not available in fixtures with sections 2 and shorter if there is uplight and downlight.
- <sup>3</sup>Consult for custom finish options
- <sup>4</sup>Consult for custom flair options
- <sup>5</sup>Emergency battery backup is integrated in fixtures 4' and longer
- <sup>6</sup>(O) is optional



Dimensions and specifications subject to change without notice.



JOB NAME:

CAT#:

TYPE:

**FLAIR BRACKET COLORS AND FINISHES**



Gloss Black  
(GB)



Matte Black  
(BK)

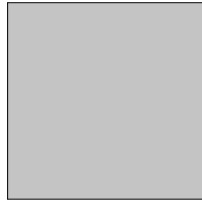

Matte Silver  
(SL)



Statuary Bronze  
(BZ)

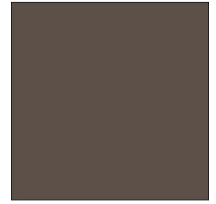

Glimmer (Iron)  
(IR)

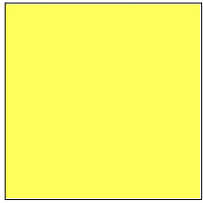

Safety Yellow  
(YL)

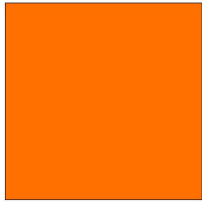

Safety Orange  
(OR)



Red  
(RD)



Fire Engine Red  
(FR)



Blue  
(BL)

**NOTE:** Factory offers any Tiger Drylac RAL finish, contact Saylite for more information. Consult factory for information on specialty "real wood" finishes.

Dimensions and specifications subject to change without notice.





JOB NAME:

CAT#:

TYPE:

**APPLICATIONS**

**The Octagon**

The Transform Series creates a new method for customizing the lighting in your space. Choose from multiple different bracket styles and fixture lengths to construct a unique, personalized lighting system. The popular 44P fixtures provide bright, white and energy efficient illumination with up and down lighting options. Rejuvenate your space with an interesting custom fixture!

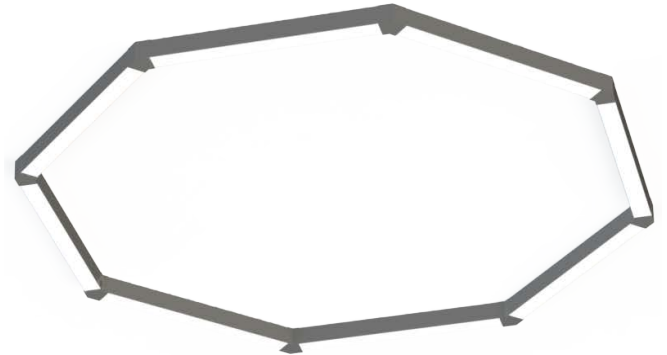

**FEATURES & BENEFITS**

- 4 standard fixture sizes – 24", 48", 72", and 96"
- Customizable bracket colors available
- Pendant mount for most ceilings
- Many lumen package / wattage options via programmable drivers
- CRI >80 (90 CRI available)
- >50,000 hrs of L70 LED life
- Power factor >0.90

**DIMENSIONS**

Part	D
PGN44-P34X34	77"
PGN44-P58X58	140"
PGN44-P82X82	203"
PGN44-P108X108	265"

D = Diameter

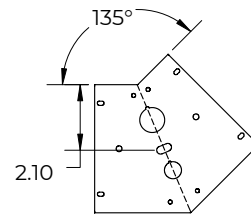
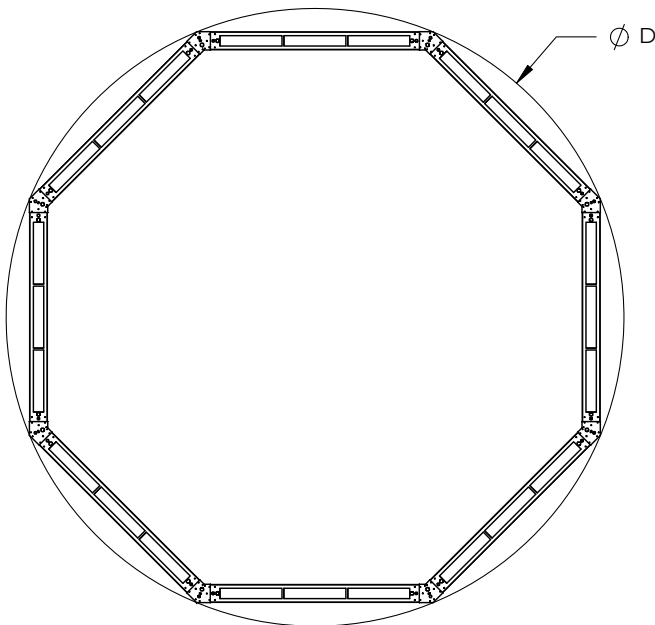

135° Bracket

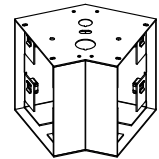

Dimensions and specifications subject to change without notice.





JOB NAME:

CAT#:

TYPE:

**ORDERING**

EXAMPLE: PGN44-P 203 LED 576 DMV BK SF 30 RD EM14 -OT

**PGN44 — P**

**LED**

1. SERIES	2. MOUNTING	3. DIAMETER <sup>1</sup>	4. GEAR	5. DISTRIBUTION	6. WATTAGE/LUMENS <sup>2</sup>	7. DRIVER		
<b>PGN44</b>	<b>P</b> Pendant	<b>77</b> 77" Dia.	<b>LED</b>	<b>Blank</b> Downlight (std.)	<b>Downlight</b>	<b>DMV</b> 120-277V Multivolt 0-10V Dimmable		
		<b>140</b> 140" Dia.					<b>1U2D</b> Uplight and Downlight	<b>77 in.</b>
		<b>203</b> 203" Dia.						<b>192</b> 192 Watts 19200 Lumens <b>140 in.</b>
		<b>265</b> 265" Dia.					<b>384</b> 384 Watts 19200 Lumens <b>203 in.</b>	
					<b>1 Up and 2 Down Only</b>			
					<b>77 in.</b>			
					<b>304</b> 304 Watts 11200U-19200D <b>140 in.</b>			
					<b>608</b> 608 Watts 22400U-38400D <b>203 in.</b>			
					<b>912</b> 912 Watts 33600U-57600D <b>265 in.</b>			
					<b>1216</b> 1216 Watts 44800U-76800D			

8. FINISH <sup>3</sup>	9. LENS	10. CRI	11. COLOR TEMP	12. FLAIR <sup>4</sup>	13. EM (O) <sup>6</sup>	15. CONFIGURATION
<b>BK</b> Black	<b>SF</b> Snap-in Frosted Acrylic Lens (85% transmission)	<b>Blank</b> 80	<b>30</b> 3000K	<b>RD</b> Red	<b>EM14</b> 14W Emergency Battery Backup <sup>5</sup>	<b>-OT</b> Octagon
<b>SI</b> Silver		<b>9</b> 90	<b>35</b> 3500K	<b>BL</b> Blue		
<b>WH</b> White			<b>40</b> 4000K	<b>BK</b> Matte Black		
			<b>50</b> 5000K			

**Notes:**

- <sup>1</sup>Octagon configurations are measured by an overall system diameter.
- <sup>2</sup>Wattage and lumen values are total for the system. Minimum fixture wattage of 10W. Minimum 5W per fixture foot uplight and downlight. Maximum 9W per fixture foot uplight and 18W per fixture foot downlight. Power feed cable is 18AWG, power drop is required every 800W or 48 feet for 0-10V dimming, whichever comes first. EM not available in fixtures with sections 2' and shorter if there is uplight and downlight.
- <sup>3</sup>Consult for custom finish options
- <sup>4</sup>Consult for custom flair options
- <sup>5</sup>Emergency battery backup is integrated in fixtures 4' and longer
- <sup>6</sup>(O) is optional



Dimensions and specifications subject to change without notice.





JOB NAME:

CAT#:

TYPE:

**FLAIR BRACKET COLORS AND FINISHES**



Gloss Black  
(GB)



Matte Black  
(BK)



Matte Silver  
(SL)



Statuary Bronze  
(BZ)

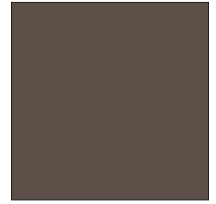

Glimmer (Iron)  
(IR)

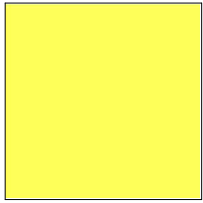

Safety Yellow  
(YL)

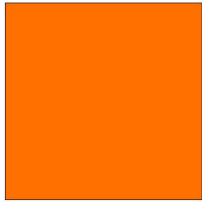

Safety Orange  
(OR)



Red  
(RD)



Fire Engine Red  
(FR)



Blue  
(BL)

**NOTE:** Factory offers any Tiger Drylac RAL finish, contact Saylite for more information. Consult factory for information on specialty "real wood" finishes.

Dimensions and specifications subject to change without notice.





JOB NAME:

CAT#:

TYPE:

**APPLICATIONS**

Transform the lighting in your space using PGN44 (polygon 4"x4") series fixtures to provide bright, white and energy efficient illumination. Choose different bracket styles and fixture lengths to construct a completely customizable lighting system with uplight and downlight options. Instantly revamp the look and feel of your space with interesting luminaires!

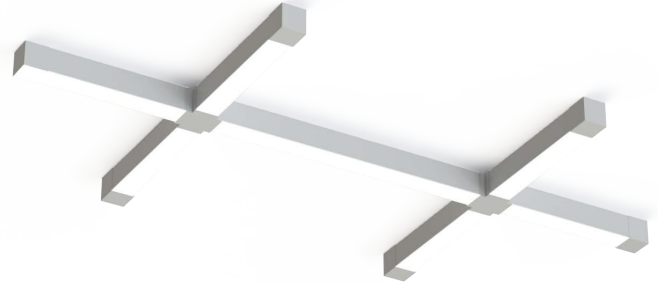

**FEATURES & BENEFITS**

- 4 standard fixture sizes – 24", 48", 72", and 96"
- Customizable bracket colors available
- Pendant mount for most ceilings
- Many lumen package / wattage options via programmable drivers
- CRI >80 (90 CRI available)
- >50,000 hrs of L70 LED life
- Power factor >0.90

**EXAMPLE CONFIGURATION PATTERNS\***

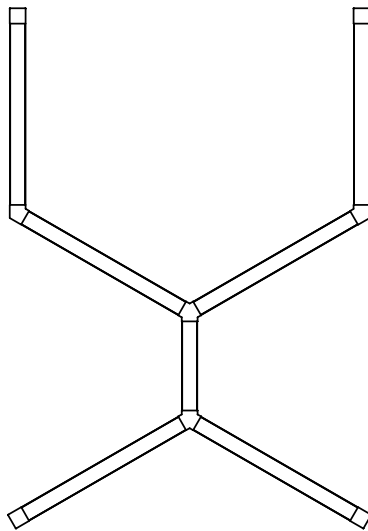

C01 - Pattern 01

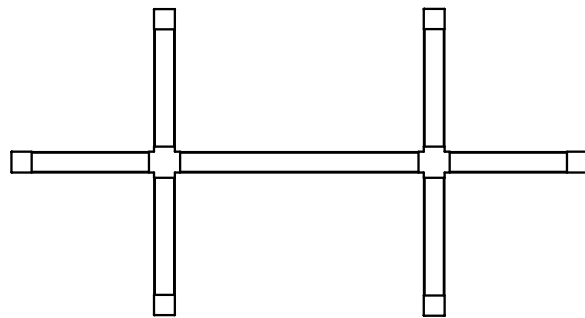

C02- Pattern 02

\*NOTE: The patterns above are examples, please consult the factory to design your own custom pattern. All custom patterns require design and drawing approval.

Dimensions and specifications subject to change without notice.





JOB NAME:

CAT#:

TYPE:

**BRACKET DIMENSIONS**

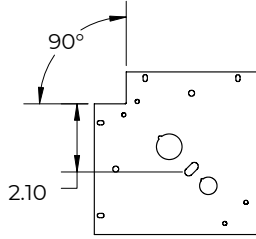

90° Bracket

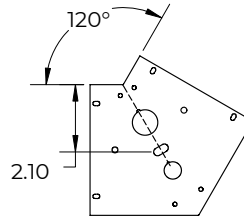
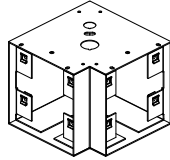

120° Bracket

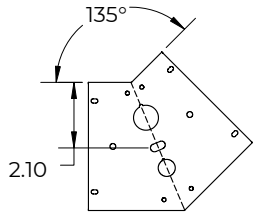
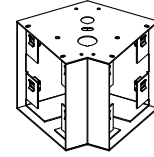

135° Bracket

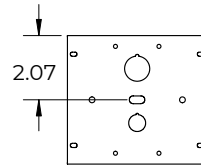
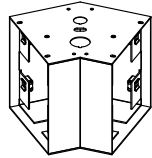

180° Bracket

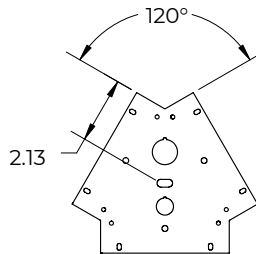
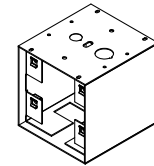

120° Y Bracket

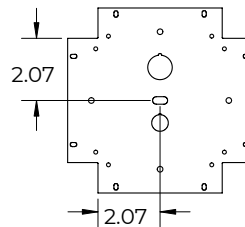
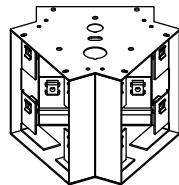

90° X Bracket

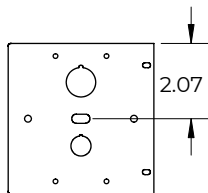
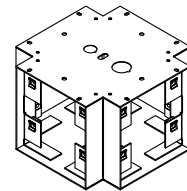

End Cap Bracket

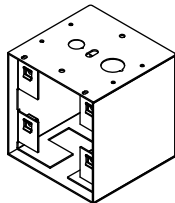

Dimensions and specifications subject to change without notice.





JOB NAME:

CAT#:

TYPE:

**FLAIR BRACKET COLORS AND FINISHES**



Gloss Black  
(GB)



Matte Black  
(BK)



Matte Silver  
(SL)



Statuary Bronze  
(BZ)

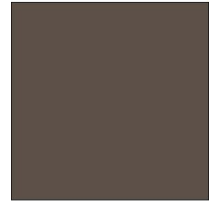

Glimmer (Iron)  
(IR)

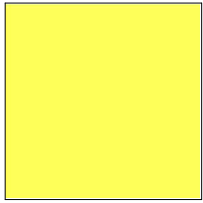

Safety Yellow  
(YL)

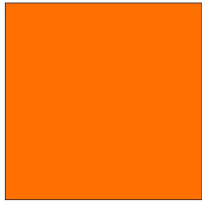

Safety Orange  
(OR)



Red  
(RD)



Fire Engine Red  
(FR)



Blue  
(BL)

**NOTE:** Factory offers any Tiger Drylac RAL finish, contact Saylite for more information. Consult factory for information on specialty "real wood" finishes.

Dimensions and specifications subject to change without notice.

