



Texas Fluorescents
Reinvented

CATALOG#: _____
PROJECT: _____
TYPE: _____

Series SBR

LED Recessed Flat Panel

The refreshing SBR Series offers luxurious lighting in a slim, austere design. Available in 1x4, 2x2 and 2x4 in multiple color temperatures and dimmable with 0 to 10 Volt dimming. The SBR is designed for T-Bar grid mounting and has a ballast box on top of the fixture. The panel has an unobtrusive white edge. These panels are an ideal choice for many applications including offices, circulation spaces, retail and now popular in residential kitchens remodeled to give a skylight appearance.

CONSTRUCTION

Housing is white aluminum that is sealed and Non-IC type fixture. Lens is evenly diffused frosted material. The driver is a Class 2 compliant design, featuring low voltage, limited power and is capable of 0-10V dimming as standard. Available in 40, 48 & 95 input watts. Fixture is 80CRI minimum, multiple color temperatures, sizes and wattages are available. 5 year limited system warranty. Listed by and bears cUL_{us} label.

TYPICAL OPTIONS & ACCESSORIES

Emergency battery backup, whips and frame kits.



DIMENSIONS

- 1x4- 47.50”L x 11.78”W x 4.688”H
- 2x2- 23.75”L x 23.75”W x 4.688”H
- 2x4- 47.688”L x 23.95”W x 4.688”H

FEATURES & BENEFITS

- Ultra thin LED panel light made from high-grade aluminum
- Custom finish colors available
- Rated at 50,000 hrs of L70 LED life
- CRI >80
- 0-10 Volt dimmable 120-277V
- High efficacy and UV and IR Free
- PF >0.99



ORDER INFORMATION

SERIES	DIFFUSER	WIDTH X LENGTH	GEAR	WATTAGE* ¹	DRIVER	FINISH ²	CCT	
SBR	FR Frosted	12X48	12"W x 48"L	LP	D48	DMV 0-10V Dimming	48 Watts 3,200 Lumens	
		24X24	24"W x 24"L				D40	40 Watts 3,100 Lumens
		24X48	24"W x 48"L				D80	95 Watts 6,400 Lumens
						WH White BK Black SL Silver	30K 3000K 40K 4000K 50K 5000K	

EMERGENCY³

EM14	14W Emergency battery backup
------	------------------------------

Note:

1. Consult factory for more options for wattage and board level lumens. Lumen values shown are for blank pattern, other patterns will reduce lumen output. Consult factory for more information on percentage output lost for desired pattern.
2. Standard fascia finishes are White, Black, and Silver. Please consult factory for more information and pricing on custom color options.
3. Emergency backup test button mounted on the outside of the fixture body.

*Programmable LED drivers allow custom configured wattages and corresponding lumens.

We reserve the right to change design, materials, LED's and finish in any way that will not alter installed appearance or reduce function and performance.

DRAWINGS & IMAGES

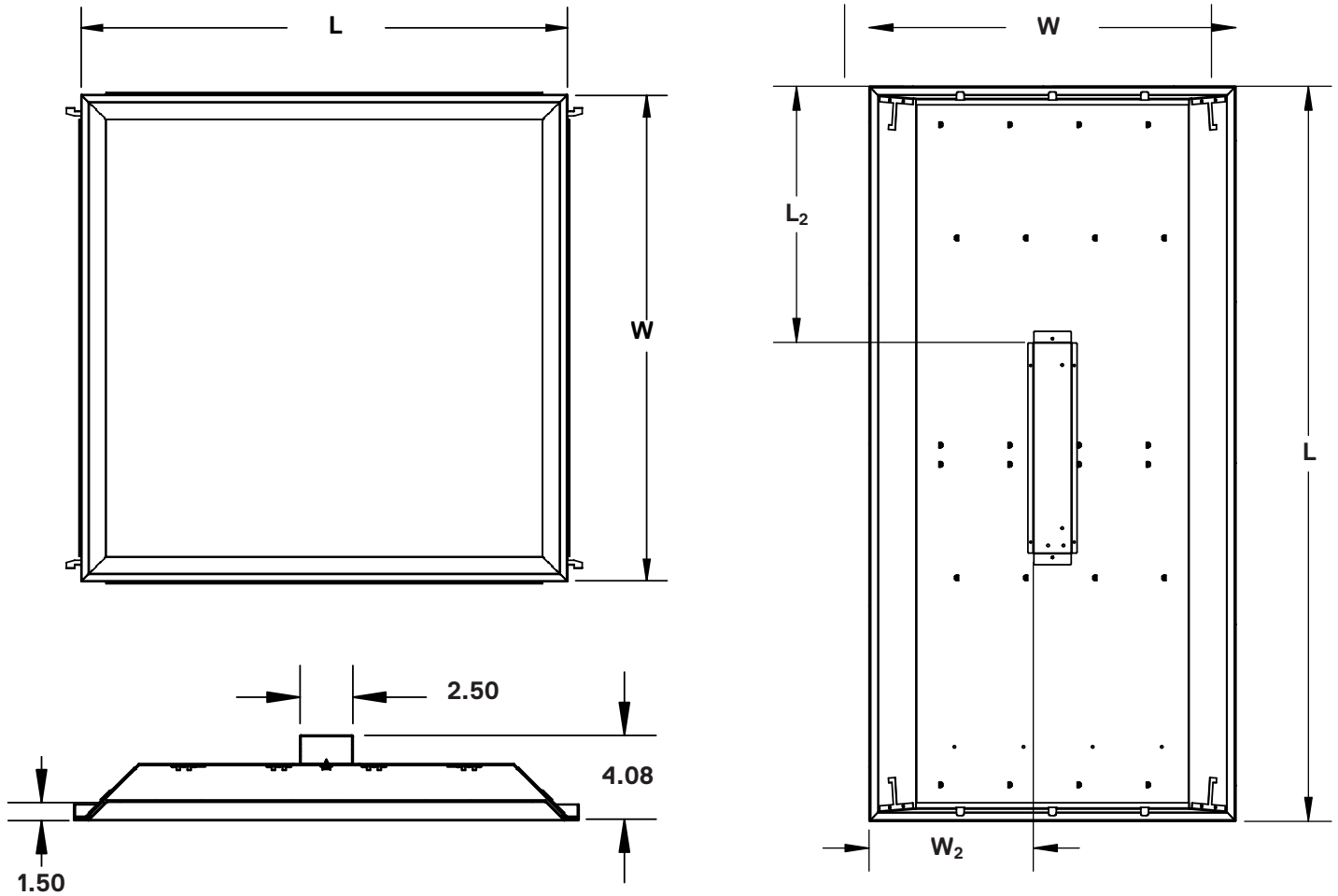

Fixture Size	W	L	W ₂	L ₂
12X48	11.78"	47.5"	4.7"	16.7"
24X24	23.75"	23.75"	10.7"	4.7"
24X48	23.75"	47.5"	10.7"	16.7"