

### FEATURES AND SPECIFICATIONS

Texas Fluorescents introduces an eye-catching selection of LED Linear Lighting channels that can be surface or pendant mounted individually or in a continuous run that put a line of light where you want it with unmatched styling and energy efficiency. Utilizing the latest in LED High Powered 24 volt Tape Lighting sized exactly to the specific channel provides micro-illumination that will not only highlight the area around it beautifully but say "look here." Ideal for general lighting applications in both commercial and residential applications for circulation spaces, high impact areas and residentially over tables, kitchen islands and home offices. The versatility and clean styling makes this an ideal choice in many applications.

Each Linear Channel is available in popular sizes, four or eight feet, or can be custom sized for your specific application within some small parameters or can be joined together for longer runs. Each channel requires a remote 24 volt driver sized to the wattage of the channel to power the LED Tape.

This Round Channel utilizes a snap in drop down lens to provide 527 lumens per foot using less than 8.78 watts.

*Surface mounting of LLLRA Series is physically possible but due to its round shape, aesthetic preference should be considered.*

### MATERIALS

Anodized Aluminum Channel is lightweight, small dimensions, and dissipates heat well, designed especially for the flexible LED Tape. Highly tooled plastic end caps screw onto the aluminum channel and protect the channel and LED tape from dust and keep the LED Tape clean and in optimum condition. A raceway in the back of the channel provides both a heat sink for the LED Tape and a holder for screws to pendant mount the Channels. The channels can be suspended or flush mounted. Flush mounting requires fastening the channel to the surface from inside the Channel prior to adding the LED Tape. So for surface mounting order Channel and LED separately. The channels are factory or field cuttable to any length but exact length should be determined by the application and the exact length of LED Tape that will provide smooth, consistent lighting through out. Joiner splines are available to join Channels together.

Snap in flush frosted lens is specially formulated for smooth illumination of the LED Tape.

### ELECTRICAL

High Powered and high quality LED Tape is flexible and designed for high temperature resistant PCB. Tape provides 120 degree illumination in choice of two color temperatures, 3000K or 4000K. The LED tape has a 50,000 average life and is 24V. Tape comes in a 16 foot reel and is designed to be cut every 2 to 4 inches depending on the exact version. Clear 18 gauge electrical wire is soldered onto the LED tape and comes standard 10 feet. All LED Tapes require a 24V remote driver, sold separately.

### WARRANTY

Five Year Limited Warranty.

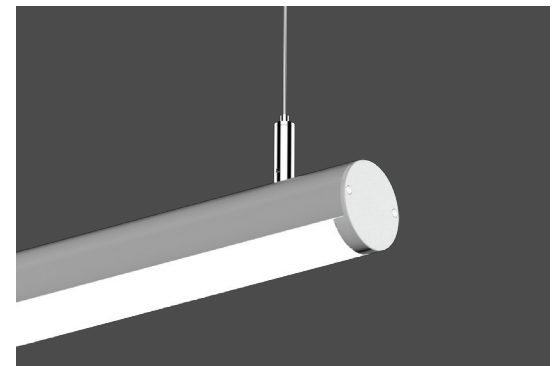

### DIMENSIONS

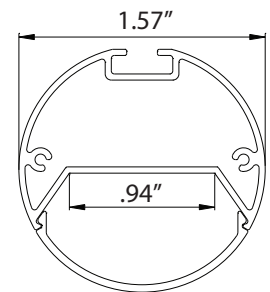

### COMPONENTS



### MOUNTING

Channels can be pendant mounted with a choice of two sizes of cable kits. Each kit comes with 2 cable kits and a canopy. Both kits are fastened to the channel with a screw that floats anywhere along the small channel on the backside of the larger channel. One kit has a small connector for just the cable to be screwed to a surface with screw and molly bolt. The second kit has a connector for both the cable and the electrical cord, and is wired through the canopy. The connector can either be fastened directly to the surface without a junction box or a white canopy and junction box bracket are provided to fasten to a standard 4 inch junction box.

Each channel requires installation of a remote driver wired to the electrical wiring provided with each channel. Channels can be combined to a single remote driver if total load does not exceed driver wattage rating.

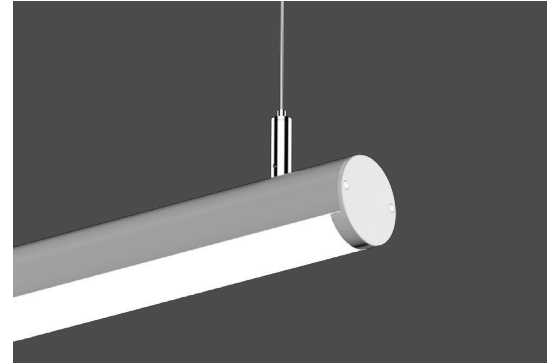

Suspension using cable kit. (Order Separately)

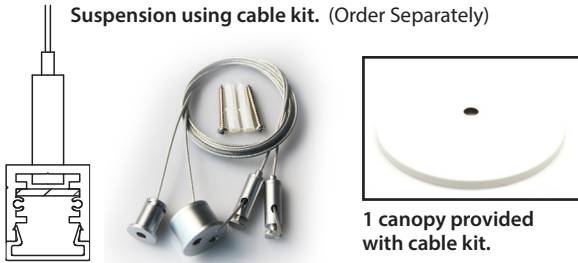

### DRIVERS (Order Separately)

Choice of constant voltage drivers including: 24 Volt Magnetic Drivers from Magnetude which is Dimmable with any Standard MLV Triac Dimmer or Electronic Driver from AC Electronic which is Dimmable with 0 - 10 Volt Dimming. See Driver Specification Sheets for details. These Class 2 remote power supplies in 24 Volt are required and need to be wired to the channels power cord in a junction box. Care should be taken to make sure the Driver is mounted within the distance recommended to the Channel itself for best performance. Wire gauge and driver alter the recommended distance. See Driver Specifications for More Detail.

## ORDERING GUIDE

The LLL Series can be ordered in multiple ways to provide the most flexibility to meet your exact applications and enable the best value. Order Complete Unit (Aluminum channel with LED Tape Installed) in Standard Sizes or Custom Sizes (Available in small increments) with Choice of Remote Drivers (Electronic for 0-10 Volt Applications or Magnetic for Low Voltage 2 Wire Applications).

Order Aluminum channel and LED tape separately to Length in Standard Sizes or Custom Sizes (Available in small increments) with Choice of Remote Drivers (Electronic for 0-10 Volt Applications or Magnetic for Low Voltage 2 Wire Applications) for field installation of Tape to channel. This option is ideal for surface mount applications and when multiple run lengths are required that need to be field measured at time of installation.

### Pendant Channels

Ordering Complete Fixture (Driver and Cable Kit Sold Separately)

Example: LLLRA48L35W2246L30KSA

LLLRA	48L	35W2246L	30K	SA
<b>Series</b>	<b>Lengths*</b>	<b>Wattage &amp; Lumen**</b>	<b>Color Temperature</b>	<b>Finish</b>
LLLRA 1.38" Dia. ROUND BODY	<b>Popular Sizes</b> 48L 47.75" 97L 97"	35W2246L 35 System Watts, 2246 Delivered Lumens - Designated for 48L  69W4492L 69 System Watts, 4492 Delivered Lumens - Designated for 97L	30K 3000K 40K 4000K	SA Satin Aluminum - Consult for Custom Finishes

#### Specifying Custom Size

#### \*Determine the Size

(Choose any Size from 2" to 98" in 2" Increments)  
\_\_\_L - Custom Length in Inches in 2" Multiples

#### \*\*Calculate Wattage and Lumens

Wattage: Multiply Length in Inches x .73  
Lumens: Multiply Length in Inches x 44.5  
\_\_\_W = .73 x \_\_\_Inches      \_\_\_L = 44.5 x \_\_\_Inches

### Ordering Channel and Tape Components (Driver Sold Separately)

Example: LLLRAE48LSA

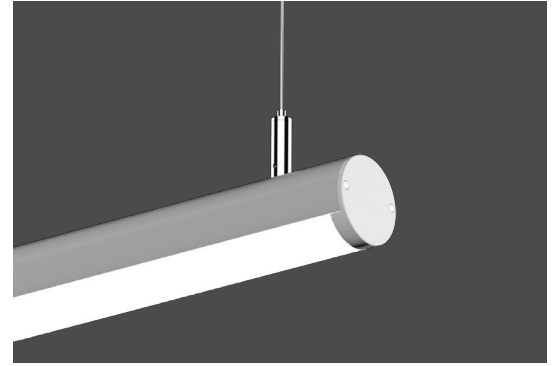

<b>LLLRAE</b>	<b>48L</b>	<b>SA</b>
<b>Series</b>	<b>Lengths*</b>	<b>Finish</b>
LLLRAE 1.38" Dia. ROUND BODY	<b>Popular Sizes</b> 48L 47.75" 97L 97"	SA Satin Aluminum - Consult for Custom Finishes

#### Specifying Custom Size

#### \*Determine the Size

(Choose any Size from 2" to 98" in 2" Increments)  
\_\_\_L - Custom Length in Inches in 2" Multiples

### Tape Only

Example: LLLRAT48L35W24V30K

<b>LLLRAT</b>	<b>48L</b>	<b>35W</b>	<b>24V</b>	<b>30K</b>
<b>Series</b>	<b>Lengths*</b>	<b>Wattage**</b>	<b>Voltage</b>	<b>Color Temperature</b>
LLLRAT	48L 47.75" 97L 97"	35W 35 Watt 69W 69 Watt	24V	30K 3000K 40K 4000K

#### Specifying Custom Size

#### \*Determine the Size

(Choose any Size from 2" to 98" in 2" Increments)  
\_\_\_L - Custom Length in Inches in 2" Multiples

#### \*\*Calculate Wattage and Lumens

Wattage: Multiply Length in Inches x .73

Lumens: Multiply Length in Inches x 44.5

\_\_\_W = .73 x \_\_\_Inches      \_\_\_L = 44.5 x \_\_\_Inches

### Mounting Kits (Order Separately)

Part Number	Descriptions
HC601WH*	Cable kit with 6' Cable and Power feed/Cable Incl. and White Canopy
HC602WH*	Cable kit with 12' Cable and Power feed/Cable Incl. and White Canopy

\*Consult for different color canopies

### Accessories (Order Separately)

Part Number	Descriptions
LLLACAPSA	Extra End Caps - Satin Aluminum
LLLRAJOIN	Joiner to Join Two Channels

### Drivers - Choice of Magnetic or Electronic Drivers.

Magnetic Driver from Magnitude is Dimmable with any Standard MLV Triac Dimmer or Electronic Driver from AC Electronic is Dimmable with 0 - 10 Volt Dimming. See Driver Specification Sheets for details.

Brand	Part Number	Maximum Wattage	Dimensions	Remote Distance (max)
Magnitude	MTIM40L24DC	40W	5.6"L X 2.14"W X 2"H	20ft
Magnitude	MTIM60L24DC	60W	6.55"L X 2.55"W X 2.25"H	15ft
Magnitude	MTIM100L24DC	100W	6.55"L X 2.55"W X 2.25"H	10ft
Magnitude	MTIM150L24DC	150W	6.55"L X 2.55"W X 2.25"H	5ft
AC Electronic	ACA25VD24H104	25W	9.5"L X 1.7"W X 1.14" H	18ft
AC Electronic	ACA60VD24H25	60W	9.5"L X 1.7"W X 1.14" H	18ft
AC Electronic	ACA100VD24H41	100W	9.5"L X 2.4"W X 1.46" H	18ft

Output Voltage - 24VDC.

### INSTALLATION INSTRUCTIONS

#### Pendant Mount Only

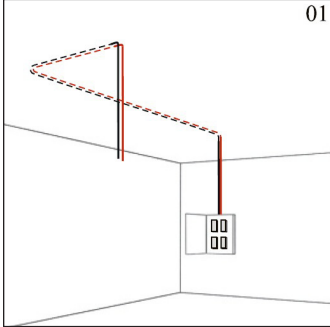

01  
Wire wall switch to driver and junction box.

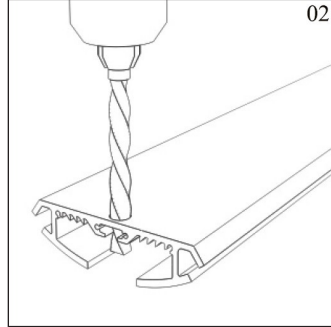

02  
Drill holes for power cord and to mount to surface.

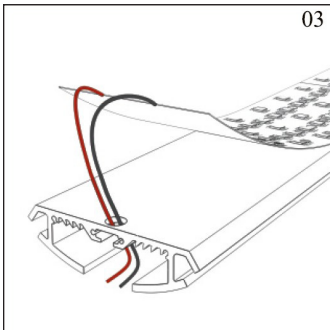
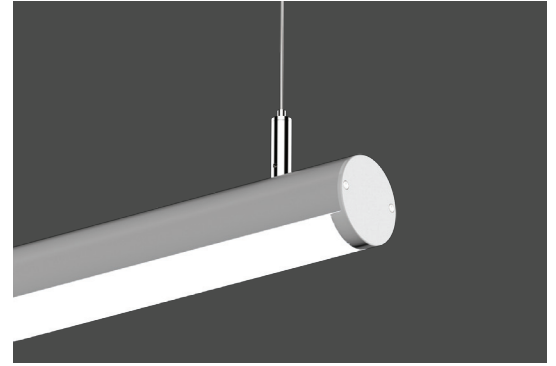

03  
Mount LED tape to channel and wire channel.  
(LED Tape sold separately)

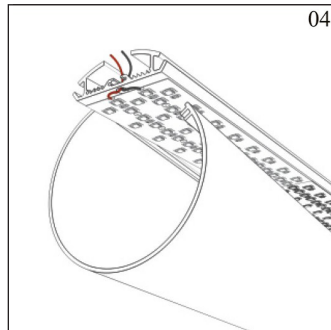

04  
Snap in lens.

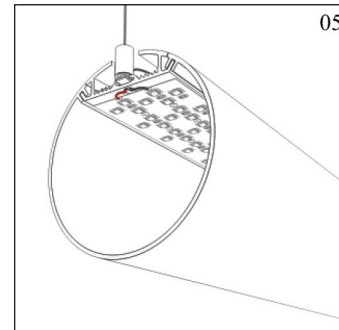

05  
Mounting for cable kit can slide anywhere along channel.

#### Joining 2 Channels (Joiner sold separately)

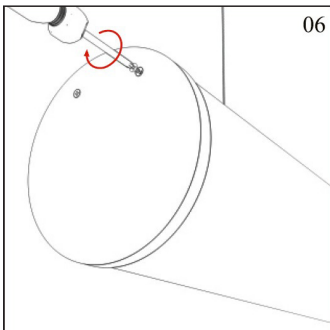

06  
Screw end caps to channel.

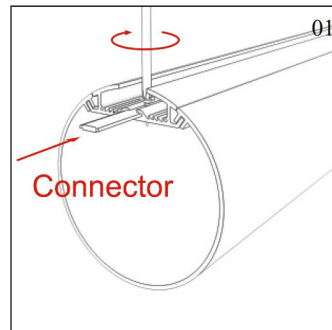

01  
Add Joiner accessory in raceway on top of channel to ensure proper alignment of channels.  
Connector

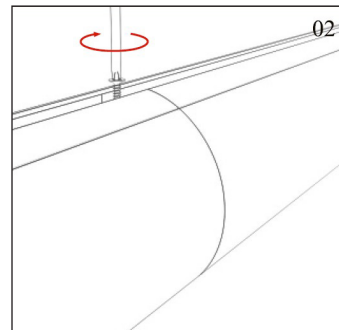

02  
Connect next channel to Joiner accessory and align.