

SBC-Pendant Mount Installation Instructions

Overview

WARNINGS

- This product must be installed in accordance with all applicable codes by a person familiar with the product.
- Each fixture must be **properly supported** during install.
- **DO NOT** join fixtures on the floor prior to lifting, or damage will occur.
- **Before beginning installation**, review our complete list of warnings by visiting www.saylite.com/warnings.

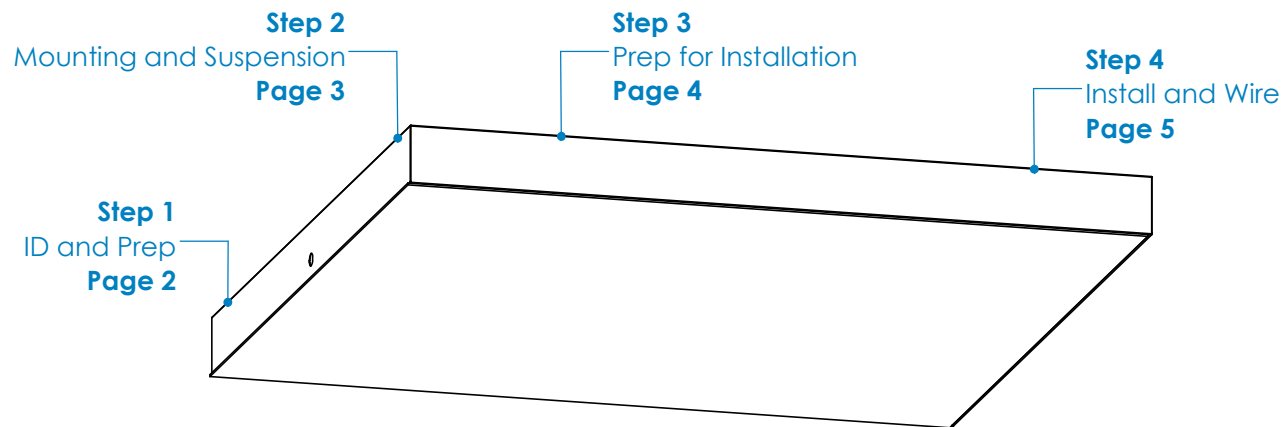

SBC-Pendant Mount Installation Instructions

Step 1 - Identification and Preparation

A. Identify Fixtures

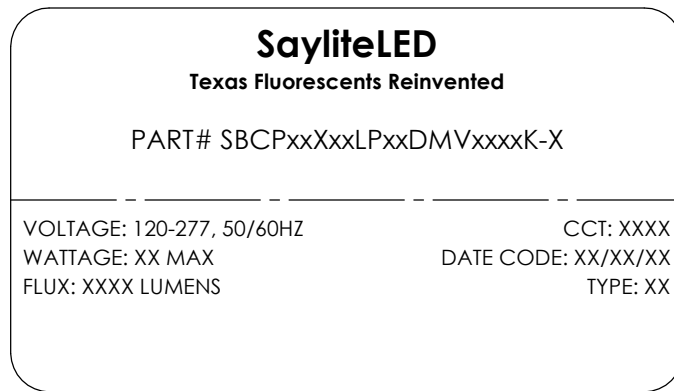

B. Tools Needed

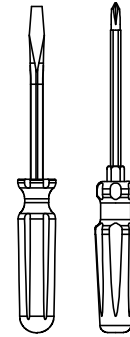

Screwdrivers



Pliers

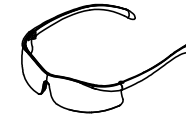

Safety Glasses

- Use labels found on the box and inside the fixture bodies to identify bodies.
- **NOTE:** Locations of labels can vary.
- Remove all fixtures from their boxes.
- Organize fixtures based on their labels at the install location.

- Always use proper safety equipment when installing fixtures.
- Tools shown are recommended for standard install. Tools needed may vary based on actual install location conditions.

Kitted Hardware

- Saylite has provided the items listed here, with their Saylite part numbers listed. These items can be found in separate boxes shipped with the fixture.
- Ensure all parts are accounted for and set them aside until needed.
- Any additional hardware needed for this installation will be provided by others.

SBC-Pendant Mount Installation Instructions

Step 2 - Mounting and Suspension



Texas Fluorescents Reinvented

Mounting Options

Drywall or other hard surfaces - HC712 Hanging Kit

- Install hanging kits at mounting locations.
- Ensure hanging kits are secure.
- Prepare fixture for mounting.

Other hard surfaces include: wood, sheet metal panels, steel beams, concrete or masonry. Use hardware appropriate for each surface and material type.

Suspension Locations

X = Suspension Dimensions

Refer to Assembly Drawings and building plans to determine exact mounting, suspension points, and power feed locations.

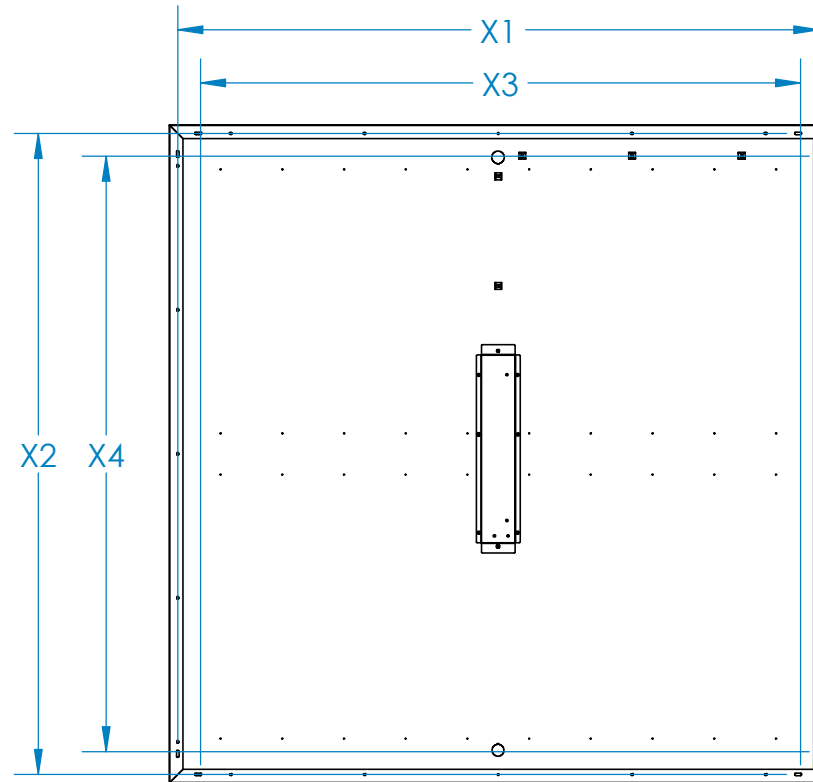

SBC-Pendant Mount Installation Instructions

Step 3 - Prepare for Installation

A. Remove 7/8" Knockout

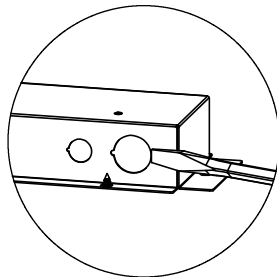
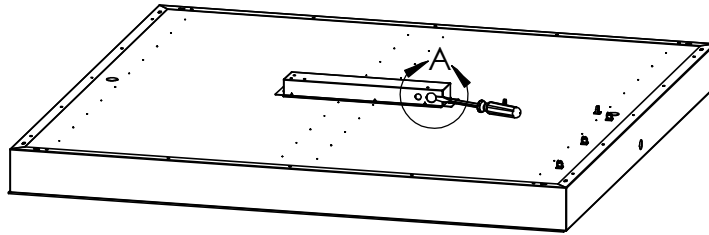

DETAIL A
SCALE 1 : 4

- Use a flat head screwdriver and gently pry up to remove the 7/8" knockout on the back of the fixture.

B. Install Hanging Kits

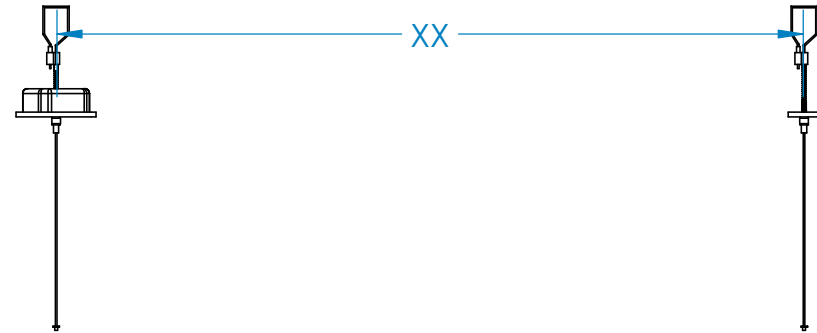

- Install the hanging kits to the ceiling at the desired mounting locations.
- Ensure that hanging kits are properly secured.
- Refer to hanging kit installation guide for more information.

SBC-Pendant Mount Installation Instructions

Step 4 - Install and Wire the Fixture

A. Install the Fixture

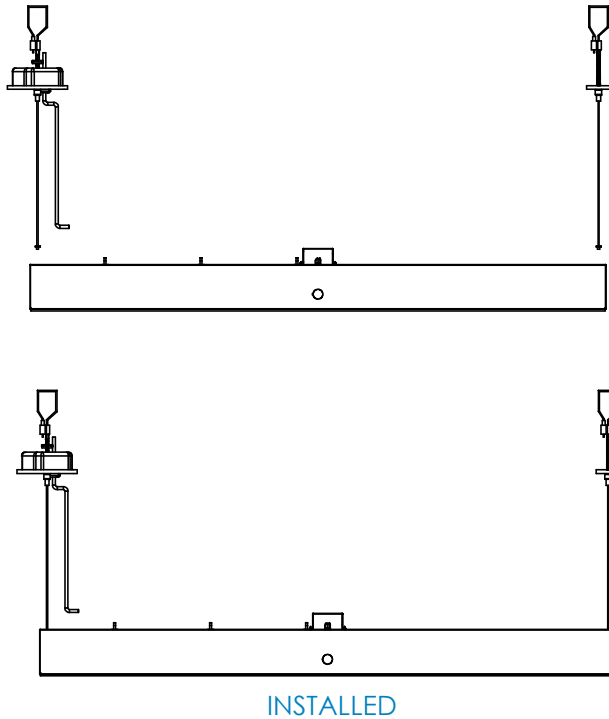

- Insert the paddle toggles to the mounting slots on the back of the fixture by rotating the paddles as parallel as possible to the hanging cables.

B. Connect Fixture Wiring

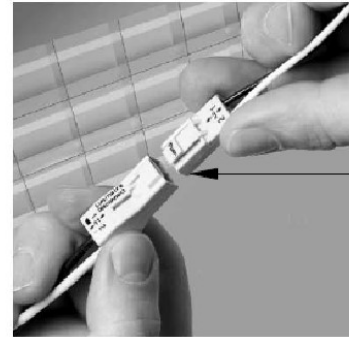

WIRING LEGEND		
BLACK	HOT	Line Voltage
WHITE	NEUTRAL	Line Voltage
GREEN	GROUND	
GRAY	DIMMING	0-10V DC
VIOLET	DIMMING	0-10V DC

- Wire fixture to the incoming power supply using the provided quick disconnect clip as shown. Route the power cable thru the wire clips installed on the back of the fixture.
- For dimming option, refer to wiring legend above.
- Use UL approved connectors only. Follow all local, state and national codes.
- Fixture installation is now complete.