

# Installation Instructions

## Important

READ THIS INSTRUCTION CAREFULLY BEFORE INSTALLATION. KEEP IT FOR FURTHER REFERENCE

MAKE ELECTRICAL AND GROUNDED CONNECTIONS IN ACCORDANCE WITH THE NATIONAL ELECTRICAL CODE AND ANY APPLICABLE CODE. ALWAYS TURN OFF THE POWER SUPPLY BEFORE INSTALLATION.

THIS PRODUCT MUST BE INSTALLED IN ACCORDANCE WITH THE APPLICABLE INSTALLATION CODE BY A QUALIFIED ELECTRICIAN WHO IS FAMILIAR WITH THE CONSTRUCTION AND OPERATION OF THE PRODUCT AND THE HAZARDS INVOLVED.

### WARNING:

- ⚠ Risk of fire or electric shock. Fixture installation requires knowledge of luminaires electrical systems. If not qualified, DO NOT attempt installation. Contact a qualified electrician.
- ⚠ Risk of fire or electric shock. Suitable for wet locations. Always turn off the power supply before installation.
- ⚠ Risk of fire or electric shock. Suitable for non-insulated surface and frame. DO NOT cover fixture with insulation liner or similar material.
- ⚠ DO NOT install fixture on unstable, loose or easily breakable surface.
- ⚠ DO NOT exert force on the surface of the fixture.

## Installation and Electrical Connection

### Tools Requirements:

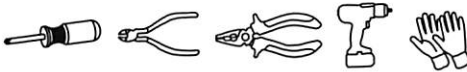

### Packing list:

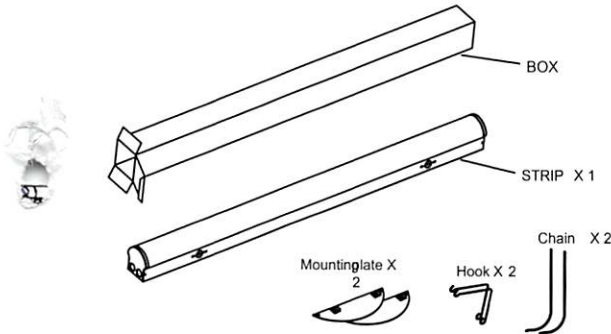

### Mounting options:

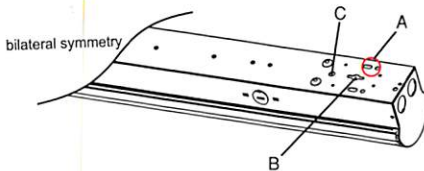

A. Chain and V hook mounting.

B. Surface mounting.

C. T-Bar Clip installation hole.



### ⚠ WARNING

**RISK OF FIRE, ELECTRIC SHOCK OR PERSONAL INJURY**

Before installation, turn power off.

# STRIP SERIES

## Installation Steps

A:

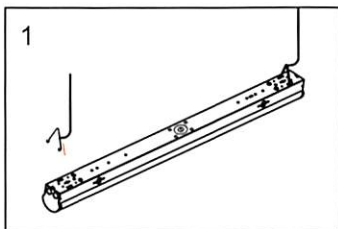

1. Tie hook with chain and then insert it into installation hole.

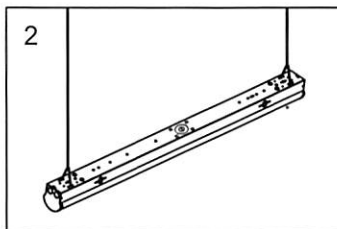

2. Fix chain to installation location, adjust the height of chain until fixture is balanced.

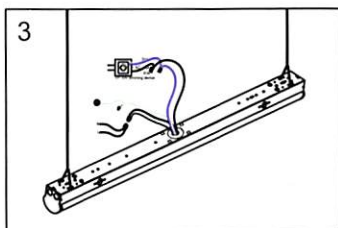

3. Connect AC wire and dimming wire.

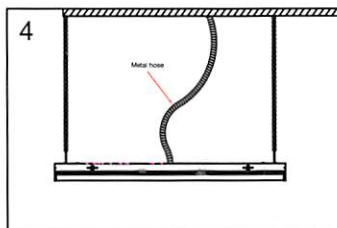

4. Wrap wires with metal material.

B:

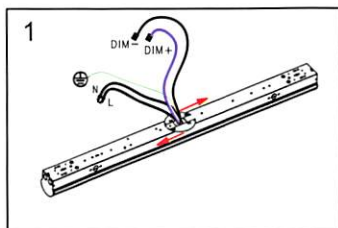

1. Lock the Mounting plate.

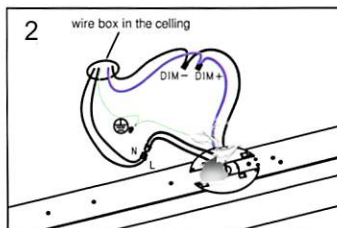

2. Connect AC wire and dimming wire.

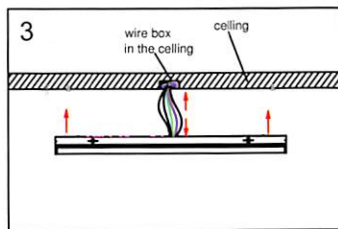

3. Lift up the fixture and put wires into box.

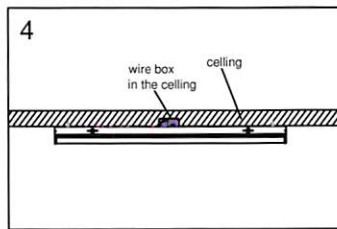

4. Lock the fixture by nail.

C:

### T-Bar clip mounting

Fix fixture to T-bar ceiling grid with T-bar clips which provided by customer.  
Refer to the left drawing, fix T-bar clips on Position 'C'.